

PSR0601

 Shaft dia.(轴径) $\phi 6$ Lead(导程)1mm

C5

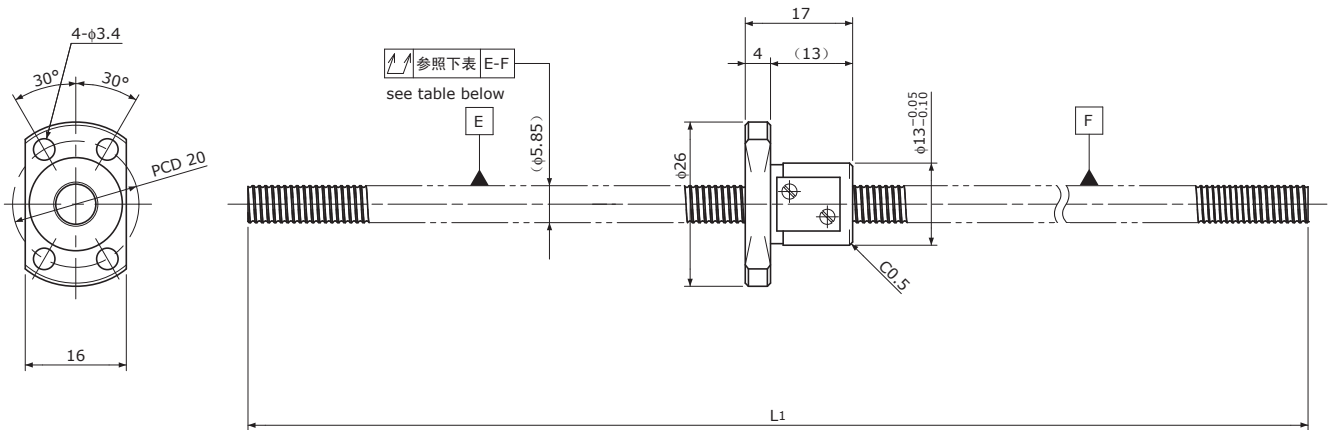

Unit(单位): mm

Ball Screw Specifications		规格
Ball size	钢珠直径	$\phi 0.8$
Number of thread	螺纹条数	1
Thread direction	螺纹方向	Right 右
Shaft root dia.	丝杠轴低径	$\phi 5.3$
Number of circuit	循环数	3.7×1
Material 材质	Shaft 轴	S55C
	Nut 螺母	SCM415H
Surface hardness 螺纹部表面硬度		HRC58~ (Thread area)
Anti-rust treatment 防锈处理		Anti-rust oil 防锈油

Unit(单位): mm

Ball Screw Model 滚珠丝杠型号	Travel 行程	Shaft length 丝杠轴长度	Travel deviation 代表移动量误差 e_p	Total Run-out 全跳动 \nearrow	Axial play 轴向间隙	Basic Load Rating 基本额定负载 N	
		L_1				Dynamic 额定动负载 C_a	Static 额定静负载 C_{0a}
PSR0601-200R200C5	175	200	± 0.020	0.050	~ 0.005	680	1200

Note) Please designate end-journal profile with your sketch. 注)轴端追加工请提供图纸。