

PSR0801

 Shaft dia.(轴径) $\phi 8$ Lead(导程)1mm

C5

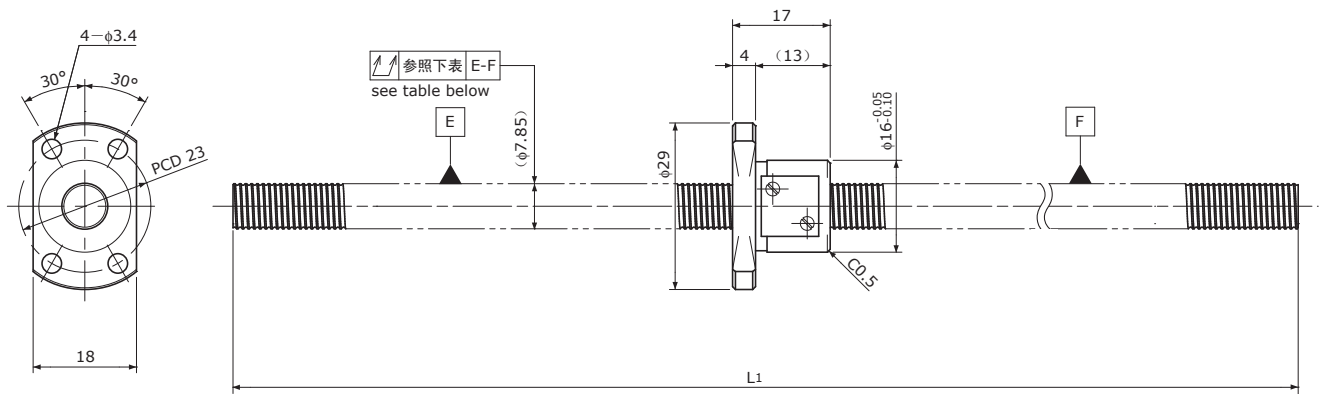

Unit(单位): mm

Ball Screw Specifications 规格		
Ball size 钢珠直径	$\phi 0.8$	
Number of thread 螺纹条数	1	
Thread direction 螺纹方向	Right 右	
Shaft root dia. 丝杠轴低径	$\phi 7.3$	
Number of circuit 循环数	3.7×1	
Material 材质	Shaft 轴	S55C
	Nut 螺母	SCM415H
Surface hardness 螺纹部表面硬度	HRC58~ (Thread area)	
Anti-rust treatment 防锈处理	Anti-rust oil 防锈油	

Unit(单位): mm

Ball Screw Model 滚珠丝杠型号	Travel 行程	Shaft length 丝杠轴长度	Travel deviation 代表移动量误差 e_p	Total Run-out 全跳动 \nearrow	Axial play 轴向间隙	Basic Load Rating 基本额定负载 N	
		L_1				Dynamic 额定动负载 C_a	Static 额定静负载 C_{0a}
PSR0801-230R230C5	205	230	± 0.023	0.065	~ 0.005	780	1650

Note) Please designate end-journal profile with your sketch. 注)轴端追加工请提供图纸。