

# 滚珠丝杠的技术解说 Ball Screw Technical Description

## 滚珠丝杠的特点 Feature of Ball Screws

### ●机械效率高

KSS滚珠丝杠在丝杠轴与螺母之间插入钢珠形成滚动接触,使机械效率高达90%以上,而所需扭矩则在传统进给丝杠的1/3以下。此外,还可轻松地将直线运动转换为回转运动(逆动作)(图A-81)。

### ●轴向间隙

对于传统的三角丝杠及梯形丝杠等,如果缩小其轴向间隙,则会因滑动摩擦而使旋转扭矩增大。KSS滚珠丝杠即使在消除轴向间隙的状态下也能非常轻快地转动。另外,通过采用双螺母,还可进一步提高刚性。

### ●精度高

KSS滚珠丝杠是在恒温控制下,采用超精密进给丝杠及螺量规加工技术加工、组装而成,并进行了严格的检查。其精度高,在准确定位方面具有高度可靠性。

### ●寿命长

KSS滚珠丝杠采用经过热处理的适当材料加工而成,由于进行滚动接触运动,因此摩擦阻力极小,几乎不会发生磨损,可长期保持很高的精度。

### ●High mechanical efficiency

KSS Ball Screws are fitted with steel Balls, providing rolling contact between the Nut and Screw Shaft, allowing for mechanical efficiency of over 90% and reducing the required Torque to less than one-third that of conventional Lead Screws. The design of the KSS Ball Screws also allows linear motion to be converted into rotary motion easily (Fig. A-81).

### ●Axial play

With conventional Triangular and Trapezoidal Screw threads, reducing the Axial play increases the rotational Torque due to the sliding friction. KSS Ball Screws, on the other hand, are very easily rotated, even with no Axial play. The use of Double Nuts also provides increased Rigidity.

### ●High precision

KSS Ball Screws are machined, assembled, and inspected using the technology of ultra-precision Lead Screw and Screw Gauge machining, under the temperature controlled room. High precision and accurate positioning ensure high reliability in use.

### ●Long service life

The Ball Screw movement results in virtually no wear, as the rolling-contact design, combined with the use of carefully selected heat-treated materials, results in an extremely low friction. This is the reason that high precision can be kept over long period.

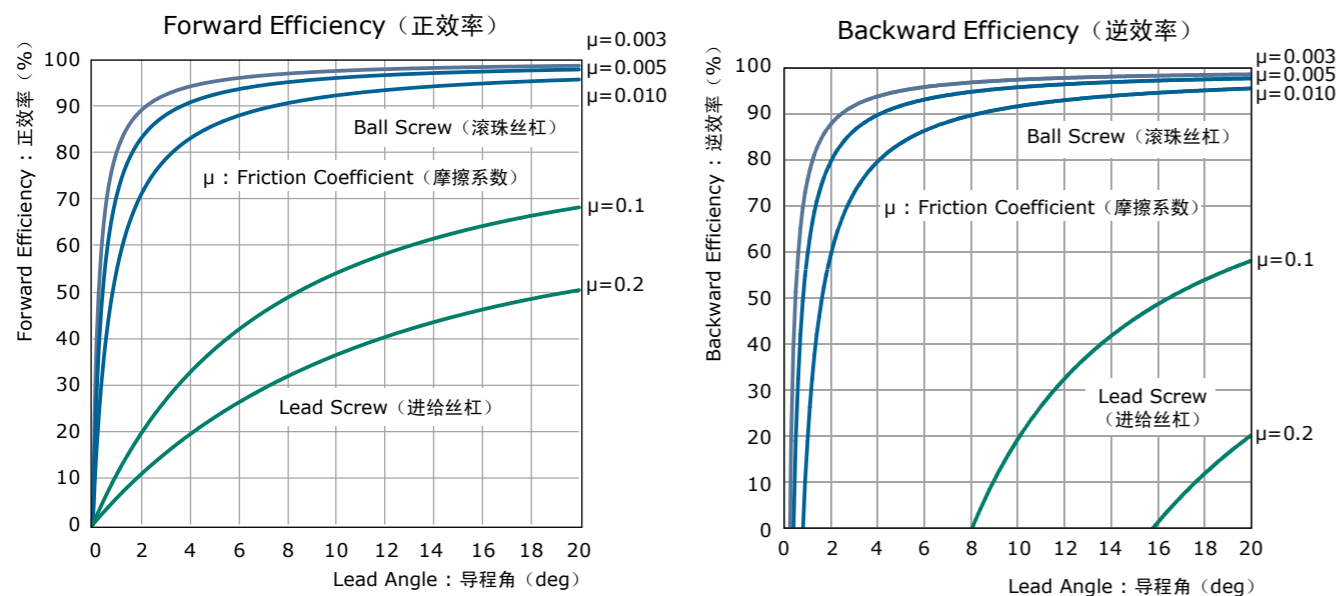

图A-81 : 机械效率  
Fig. A-81 : Mechanical Efficiency

## 滚珠丝杠的构造 Construction of Ball Screws

### ●复式回路板循环方式 Return-plate system

复式回路板循环方式,是通过安装在螺母内部的螺旋型偏转器将钢球抛出,使其沿着复式回路板的槽进行循环运动的方式。与回路管循环方式相比,具有可以缩小螺母外径的优点。在设备上安装时,如果将复式回路板部分安装在上方,则可使回转动作更加顺畅。

The Return-plate system uses coil-type deflectors incorporated inside the Nut to pick up the steel Balls and circulate them via the Return-plate channel. This system has the advantage of allowing the use of a Nut that is smaller in diameter than those employed in Return-tube systems. In addition, the upward-angle installation of the Return-plate ensures even smoother rotation.

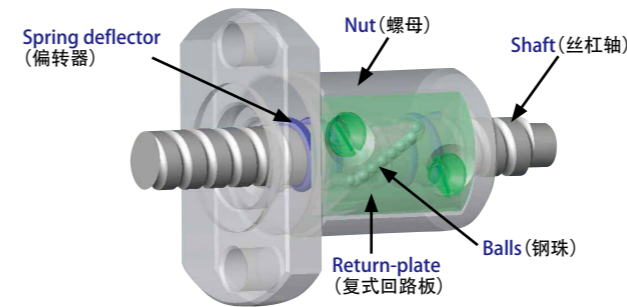

### ●端盖式循环方式 End-cap system

端盖式循环方式,是指钢珠沿着丝杠轴与螺母之间的槽滚动前行,从安装在螺母两端的循环部件(端盖)上的通路穿过螺母上的通孔,返回原位的循环方式。

The End-cap system is a recirculating system in which the Balls advance by rolling through the screw groove between the Nut and the Screw Shaft. The Balls are then returned via the holes in the Nut and the channels in the recirculating sections of the End-caps on either end of the Nut.

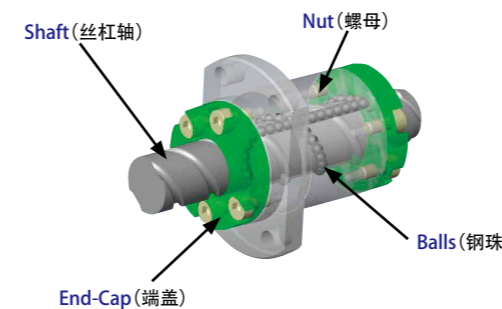

### ●回路管循环方式 Return-tube system

回路管循环方式,是指通过插入螺母中的回路管的前端,将正沿着丝杠轴与螺母之间的槽滚动的钢球取出,使其穿过回路管后,再次返回螺纹槽的循环方式。

In the Return-tube system, Balls rolling between the Nut and the Shaft are picked up from the screw groove by the end of the Return-tube built into the Nut. Then, they flow back through the Return-tube to the screw groove.

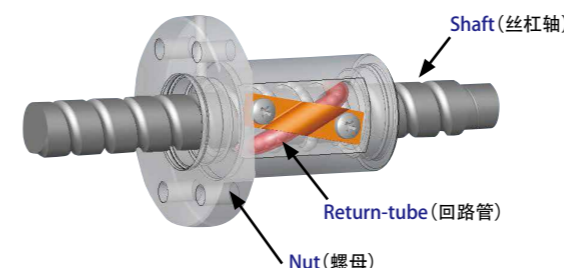

### ●陀螺式循环方式 Internal-deflector system

陀螺式循环方式最大限度地缩小了螺母的外径及长度,使微型滚珠丝杠的结构更紧凑、更轻量。钢珠在承受轴向负载的同时,在丝杠轴及螺母的钢珠滚动槽中滚动时,沿着螺母内部的陀螺槽进入相邻的滚动槽,然后再次返回卸载区,进行无限滚动循环。

The Internal-deflector system employs a lightweight Miniature Ball Screw, which enables the Nut diameter and length to be reduced to the smallest possible size. The Balls bear the load while rolling along the screw groove between the Shaft and the Nut. The Balls are continuously circulated, transferred to the adjacent groove in the screw via the Internal-deflector channel and then back to the loaded groove area.

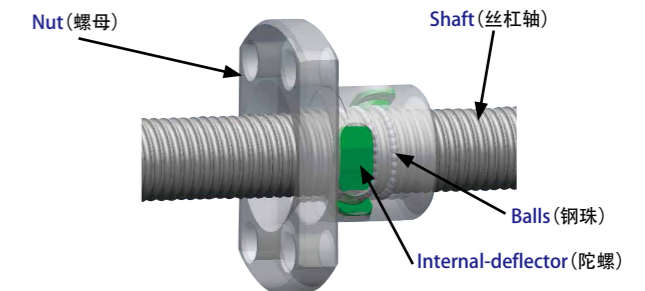

### ●偏转器式循环方式 End-deflector system

偏转器式循环方式,是指钢珠从设置于螺母内部或外部的端盖偏转器,穿过螺母通孔,在原来的滚动槽内循环的方式。与复式回路板循环方式相比,可缩小螺母的外径,是一种最适用于中导程的循环方式。

The Balls are circulated from End-deflector incorporated inside the Nut or outside the Nut through the hole in the Nut and the channels in the recirculating sections. Ball Nut diameter can be smaller than Return-plate system. This is suitable for the middle lead Ball Screws.

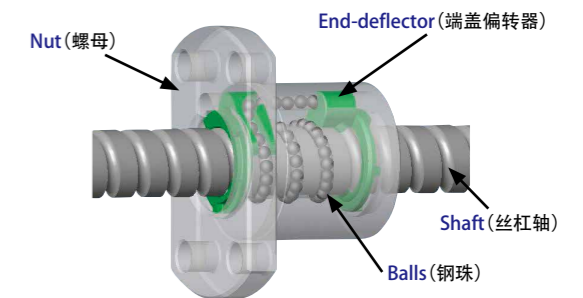

### ●螺纹槽形状 Thread Groove profile

滚珠丝杠分为由1个弧形形成的圆弧和由2个弧形形成的拱弧两种类型。KSS滚珠丝杠采用拱弧型。

Ball screws may have either a circular arc profile, formed of a single arc, or a gothic arc profile, formed from two arcs. KSS Ball Screws feature a gothic arc profile.

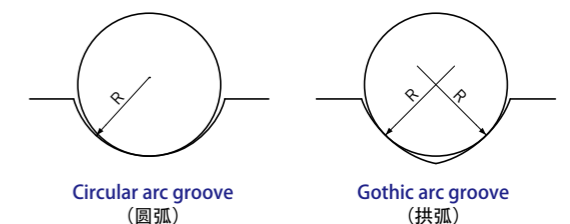

## 滚珠丝杠的生产范围

## The range of manufacturing for Ball Screws

按丝杠轴公称外径划分, KSS滚珠丝杠的生产范围为 $\phi 1.8 \sim \phi 16\text{mm}$ 。以下介绍了不同精度等级的丝杠轴的参考极限长度。具体长度会因轴端形状、材质及丝杠轴系列而异, 详情请垂询本公司。

The range of manufacturing for KSS Ball Screws is from  $\phi 1.8$  to  $\phi 16\text{mm}$  as Shaft nominal diameter. Maximum limit of overall lengths are shown below. Maximum limit of overall lengths will vary depending on the Shaft end configuration, materials and KSS series. Please inquire KSS for details.

## ●精密滚珠丝杠的生产极限长度(全长) Maximum limit of overall lengths for Precision Ball Screws

Unit(单位):mm

Shaft nominal diameter 丝杠轴公称外径	Accuracy grade 精度等级	C0	C1	C3	C5
4		90	120	160	170
6		140	180	240	250
8		200	250	330	350
10		260	320	420	450
12		320	390	510	550
14		380	460	600	660
16		450	540	700	770

注1) 超出生产极限长度时, 请垂询本公司。

Note 1) If required length exceeds the number in table above, please ask KSS representative.

## ●冷轧滚珠丝杠 (Ct7 &amp; Ct10) 的生产极限长度

## Maximum limit of overall lengths for Rolled Ball Screws (Ct7 &amp; Ct10)

Unit(单位):mm

Shaft nominal diameter 丝杠轴公称外径	Maximum length 极限长度
4	240
5	300
6	350
8	450
10	650
12	700
13	700
14	700
15	1000

注1) 超出生产极限长度时, 请垂询本公司。

注2) 冷轧滚珠丝杠的极限长度值中包括丝杠两端各25mm的不完全螺纹部分。

Note 1) If required length exceeds the number in table above, please ask KSS representative.

Note 2) Maximum limit of overall length for Rolled Ball Screws includes 25mm of incomplete thread area at both end.

## 滚珠丝杠的导程精度

## Lead accuracy of Ball Screws

JIS B1192中规定, 滚珠丝杠的导程精度是指, 相对于螺母有效移动量或丝杠轴螺纹部有效长度的代表移动量误差及波动, 以及相对于螺纹部有效长度中任意300mm及1圈( $2\pi$  rad)的波动。

表A-83、84、85中列出了不同精度等级的各种特性的公差。

Ball Screw lead accuracy conforming to JIS B1192 is specified by the tolerance of actual mean travel error over the Nut effective travel amount, or Screw Shaft effective length, travel variation and travel variation within arbitrary 300mm, travel variation within arbitrary 1 revolution ( $2\pi$  rad) over the Screw Shaft effective length. Tolerance of each accuracy grades are shown in the Table A-83, 84, 85.

图A-82: 移动量误差线图

Fig. A-82: Travel deviation diagram

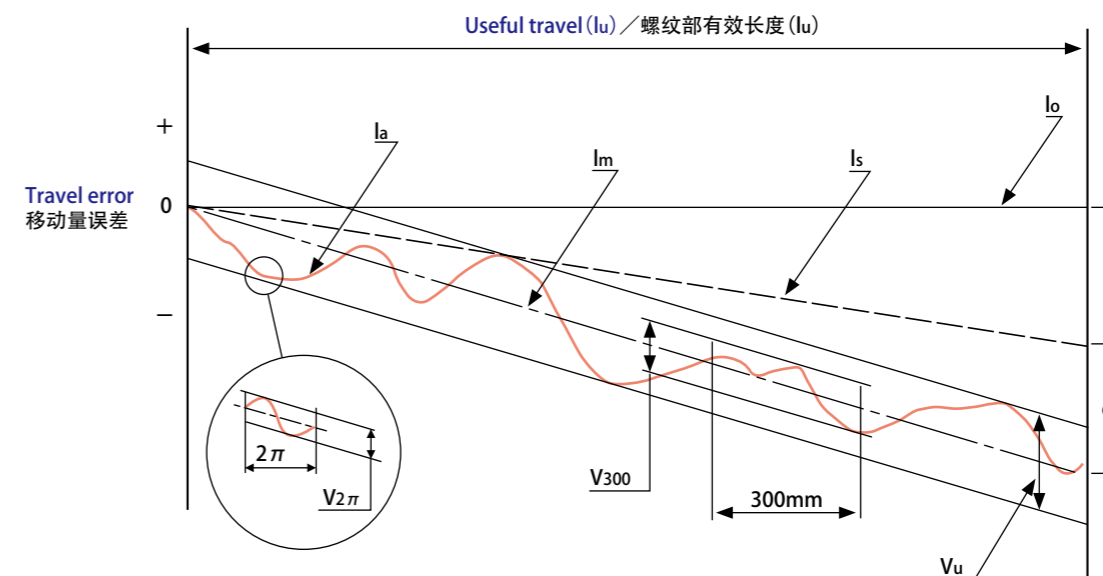

- 公称移动量 ( $l_0$ ) : 按照公称导程旋转任意圈数时的轴向移动量。  
 标准导程 (Phs) : 预测因温度上升及负载而引起的变形量, 对公称导程进行了若干补偿的导程。  
 代表移动量的目标值 (c) : 预先将标准移动量设定为正或负时的目标值。  
 标准移动量 ( $l_s$ ) : 按照标准导程旋转任意圈数时的移动量。  
 实际移动量 ( $l_a$ ) : 相对于任意丝杠轴旋转角的螺母实际轴向移动量。  
 代表移动量 ( $l_m$ ) : 代表实际移动量倾向的直线。根据表示相对于滚珠丝杠有效移动量或螺纹部有效长度的实际移动量曲线, 通过最小二乘法或类似的近似法求出。  
 代表移动量误差 ( $e_p$ ) : 与螺母的有效移动量或丝杠轴的螺纹部有效长度相应的代表移动量与标准移动量之差。  
 波动 ( $V_u$ ) : 平行于代表移动量的两条线间的实际移动量最大幅度。  
 波动 ( $V_{300}$ ) : 相对于螺纹部有效长度中任意300mm的实际移动量最大幅度。  
 波动 ( $V_{2\pi}$ ) : 相对于螺纹部有效长度中任意1圈 ( $2\pi$  rad) 的实际移动量最大幅度。

- Nominal travel ( $l_0$ ) : Travel in axial direction when rotated arbitrary number of revolution according to the Nominal lead  
 Specified Lead (Phs) : Lead given some amount of correction to the Nominal lead in order to compensate the deformation generated due to the temperature rise or the load.  
 Travel compensation (c) : Difference between the Specified travel and the Nominal travel within the valid travel.  
 Specified travel ( $l_s$ ) : Travel in axial direction when rotated arbitrary number of revolution according to the Specified lead.  
 Actual travel ( $l_a$ ) : Actual travel of Ball Nut in axial direction in respect to an arbitrary angle of rotation of Ball Screw Shaft.  
 Actual mean travel ( $l_m$ ) : Straight line which represents the tendency of Actual travel. It is obtained by the least square method or a simple and appropriate approximation method from the curve indicating the Valid travel of Ball Nut.  
 Tolerance on specified travel ( $e_p$ ) : Difference between the Actual mean travel and the Specified travel corresponding to the Valid travel of Ball Nut or the Useful travel of Ball Screw Shaft.  
 Travel variation ( $V_u$ ) : Maximum width of the Actual travel curve between the two straight lines put in parallel to the Actual mean travel line, that corresponding to Valid travel of Ball Nut or Useful travel of Ball Screw Shaft.  
 Travel variation ( $V_{300}$ ) : Maximum width of the Actual travel curve between the two straight lines put in parallel to the Actual mean travel line, that corresponding to arbitrary 300mm taken within Useful travel of Ball Screw Shaft.  
 Travel variation ( $V_{2\pi}$ ) : Maximum width of the Actual travel curve between the two straight lines put in parallel to the Actual mean travel line, that corresponding to arbitrary one revolution ( $2\pi$  rad) within Useful travel of Ball Screw Shaft.

表 A-83 : 精密滚珠丝杠 (定位用: C系列) 的代表移动量误差 ( $\pm e_p$ ) 和波动 ( $V_u$ ) 许用值  
Table A-83 : Tolerance on actual mean travel deviation ( $\pm e_p$ ) and permissible variation of precision Ball Screws (for positioning : C series)

Unit (单位):  $\mu\text{m}$ 

Accuracy Grade 精度等级		C0		C1		C3		C5	
Over 超过	Up to 以下	$\pm e_p$	$V_u$	$\pm e_p$	$V_u$	$\pm e_p$	$V_u$	$\pm e_p$	$V_u$
—	100	3	3	3.5	5	8	8	18	18
100	200	3.5	3	4.5	5	10	8	20	18
200	315	4	3.5	6	5	12	8	23	18
315	400	5	3.5	7	5	13	10	25	20
400	500	6	4	8	5	15	10	27	20
500	630	6	4	9	6	16	12	30	23
630	800	7	5	10	7	18	13	35	25
800	1000	8	6	11	8	21	15	40	27

表 A-84 : 精密滚珠丝杠 (定位用: C系列) 每300mm及1圈的波动 ( $V_{300}$ )、( $V_{2\pi}$ ) 许用值  
Table A-84 : Permissible travel variation  $V_{300}$ ,  $V_{2\pi}$  (for positioning : C series)

Unit (单位):  $\mu\text{m}$ 

Accuracy grade 精度等级	C0		C1		C3		C5	
Item 项目	$V_{300}$	$V_{2\pi}$	$V_{300}$	$V_{2\pi}$	$V_{300}$	$V_{2\pi}$	$V_{300}$	$V_{2\pi}$
Permissible value 许用值	3.5	3	5	4	8	6	18	8

表 A-85 : 相对于300mm的Ct系列 (7、10级) 的波动 ( $V_{300}$ )  
Table A-85 : Permissible travel variation  $V_{300}$  for Ct series (7,10 grade)

Unit (单位):  $\mu\text{m}$ 

Accuracy grade 精度等级	Ct7	Ct10
$V_{300}$	52	210

Ct系列 (7级、10级) 的代表移动量误差由下式求出。  
Tolerance on actual mean travel deviation ( $e_p$ ) is calculated as follows.

$$e_p = \pm \frac{l_u}{300} \times V_{300} \quad \begin{array}{l} l_u: \text{螺纹部有效长度 (mm)} \\ \text{Useful travel (mm)} \end{array}$$

为了与ISO保持一致, 滚珠丝杠的日本工业标准 (JIS B1192) 于1997年、2013进行了修订。修订后的标准制定了C系列 (原JIS标准 C0、1、3、5) 和Cp、Ct系列 (与ISO统一的标准) 的精度等级。本公司根据JIS B 1192-2013, 对0、1、3、5级采用了C系列, 对7、10级采用了Cp、Ct系列。

Japan Industrial Standard of Ball Screw (JIS B1192) was revised in 1997 and 2013 in order to correspond to ISO. Regarding accuracy grade, C series (current JIS C0, 1, 3, 5) and Cp, Ct series (standard corresponding to ISO) are established. KSS conforms to JIS B1192-2013 and adopts C series for 0,1,3,5 grade, Cp, Ct series for 7,10 grade.

## 滚珠丝杠的安装部精度 Ball Screw Run-out and location tolerances

为了与ISO保持一致, 滚珠丝杠的日本工业标准 (JIS B1192) 于1997年、2013进行了修订。修订后的标准制定了C系列 (原JIS标准 C0、1、3、5) 和Cp、Ct系列 (与ISO统一的标准) 的精度等级。C系列和Cp、Ct系列在安装部精度的标示方法和标准值上略有不同, 本公司将其统一为下图 (图A-86) 中的标示方法和标准值 (C系列), 7级、10级参考了Cp、Ct系列的标准。

Japan Industrial Standard of Ball Screw (JIS B1192) was revised in 1997 and 2013 in order to correspond to ISO. Regarding accuracy grade, C series (current JIS C0, 1, 3, 5) and Cp, Ct series (standard corresponding to ISO) are established. There are some differences between C series and Cp, Ct series in notation and tolerances for accuracy of Ball Screw mounting section. KSS uses notation of Fig. A-86 below and standard tolerance value, which conforms to C series standard, and KSS refers to Cp, Ct series standard in case of 7 and 10 grade.

图A-86 : 安装部精度的填写示例

Fig. A-86 : Description of Run-out and location tolerances for Ball Screws



表 A-88 : 相对于丝杠轴螺纹槽面的支撑部外径的半径方向圆跳动  
以及相对于丝杠轴支撑部轴线的零件安装部的半径方向圆跳动  
Table A-88 : Radial Run-out of Bearing seat related to the centerline of screw groove  
and Radial Run-out of journal diameter related to the Bearing seat

Unit(单位): μm

Shaft nominal diameter (mm) 丝杠轴公称外径 (mm)		Permissible deviation of Radial Run-out 跳动公差 (最大)					
Over 超过	Up to 以下	C0	C1	C3	C5	C7	C10
—	8	3	5	8	10	14	40
8	12	4	5	8	11	14	40
12	20	4	6	9	12	14	40

在测量该项目时, 由于受丝杠轴轴线全跳动的影响, 因此需要进行补偿。补偿方法为, 根据丝杠轴总长与支点到测量点的距离(L<sub>1</sub>,L<sub>2</sub>) 的比值(参照图A-87), 利用第A809~A811页的表A-93~98的丝杠轴轴线的全跳动公差, 求出补偿值(参照下式), 然后加上表A-88中的公差。

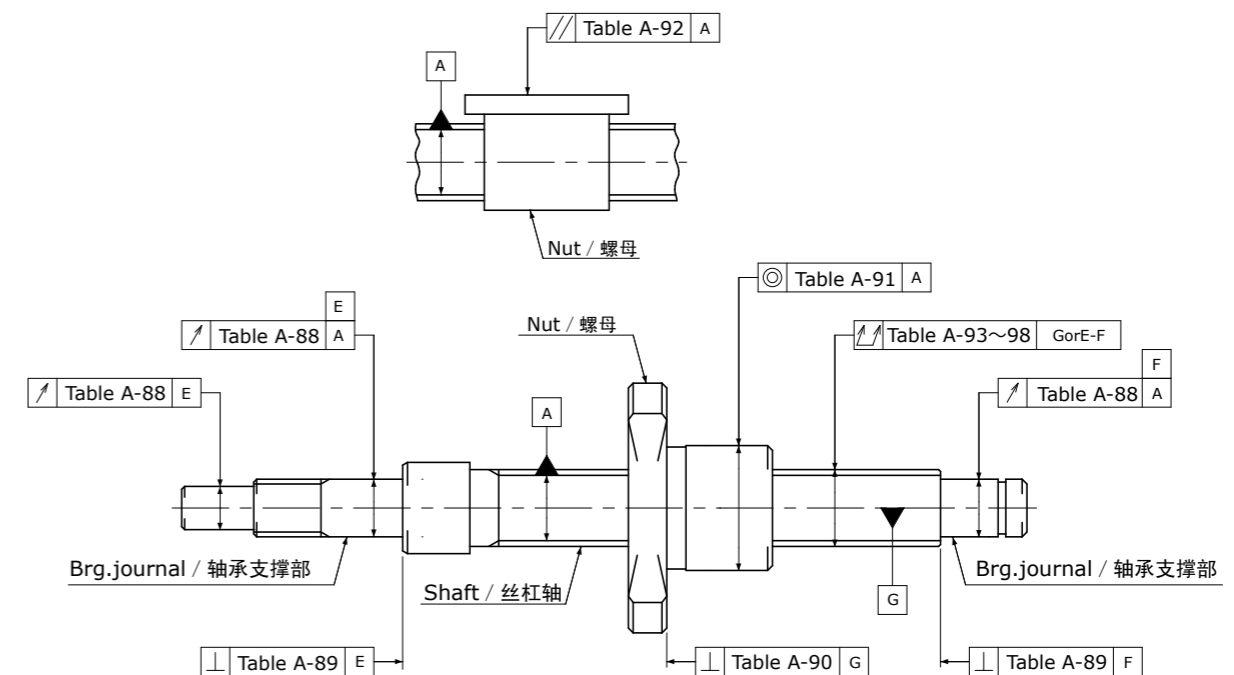
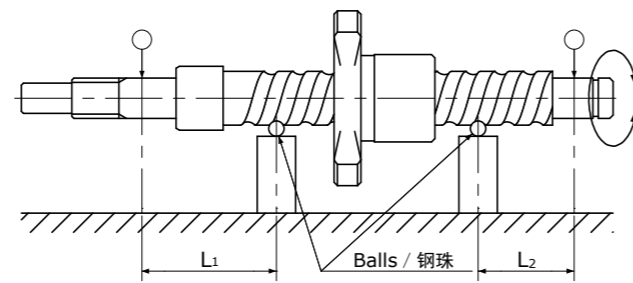

图A-87 : 圆跳动的补偿  
Fig. A-87 : Compensation of Radial Run-out

This measurement item is affected by Total Run-out of the Screw Shaft, and so it must be corrected as follows. Find the corrected value from the Total Run-out tolerances given in Tables A-93~98 on page A809~A811 using the ratio of the total Shaft length to the distance between the supporting point and the measuring point (L<sub>1</sub>,L<sub>2</sub>) (see Fig. A-87), and add the values obtained to the tolerance given in Table A-88.

$$\text{圆跳动的补偿} = \frac{\text{全跳动公差 (表 A-93~98)}}{\text{总长}} \times \text{测量间距 (L}_1\text{或L}_2\text{)}$$

$$\text{Compensation Value of Run-out} = \frac{\text{Tolerance of total Run-out (Table A-93~98)}}{\text{Total shaft length}} \times (L_1 \text{ or } L_2)$$

L<sub>1</sub>,L<sub>2</sub>: 支点到测量点的距离(mm)  
Distance btw supporting pt & measuring pt (mm)

表 A-89 : 相对于丝杠轴支撑部轴线的支撑部端面的垂直度  
Table A-89 : Axial Run-out (Perpendicularity) of Shaft (Bearing) face  
related to the centerline of the Bearing seat

Unit(单位): μm

Shaft nominal diameter (mm) 丝杠轴公称外径 (mm)		Permissible deviations of Axial Run-out (Perpendicularity) 垂直度公差 (最大)					
Over 超过	Up to 以下	C0	C1	C3	C5	C7	C10
—	8	2	3	4	5	7	10
8	12	2	3	4	5	7	10
12	20	2	3	4	5	7	10

表 A-90 : 相对于丝杠轴轴线的螺母基准端面或法兰安装面的垂直度  
Table A-90 : Axial Run-out (Perpendicularity) of Ball Nut location face related to the centerline of Screw Shaft

Unit(单位): μm

Nut outside diameter (mm) 螺母外径		Permissible deviations of Axial Run-out (Perpendicularity) 垂直度公差 (最大)					
Over 超过	Up to 以下	C0	C1	C3	C5	C7	C10
—	20	5	6	8	10	14	20
20	32	5	6	8	10	14	20
32	50	6	7	8	11	18	30

表 A-91 : 相对于丝杠轴轴线的螺母外周面(圆柱形时)的半径方向圆跳动  
Table A-91 : Radial Run-out of Ball Nut location diameter related to the centerline of Screw Shaft

Unit(单位): μm

Nut outside diameter (mm) 螺母外径		Permissible deviations of Radial Run-out 跳动公差 (最大)					
Over 超过	Up to 以下	C0	C1	C3	C5	C7	C10
—	20	5	6	9	12	20	40
20	32	6	7	10	12	20	40
32	50	7	8	12	15	30	60

表 A-92 : 相对于丝杠轴轴线的螺母外周面(平面安装时)的平行度  
Table A-92 : Parallelism of rectangular Ball Nut related to the centerline of Screw Shaft

Unit(单位): μm

Mounting length (mm) 标准安装长度 (mm)		Permissible deviations of Parallelism 平行度公差 (最大)					
Over 超过	Up to 以下	C0	C1	C3	C5	C7	C10
—	50	5	6	8	10	17	30
50	100	7	8	10	13	17	30

表 A-93：丝杠轴轴线的半径方向全跳动(C0)

Table A-93 : Total Run-out in radial direction of Screw Shaft related to the centerline of Screw Shaft (C0) Unit(单位):mm

		Shaft nominal diameter 丝杠轴公称外径		
		—	8	12
Over/超过		—	8	12
Up to/以下		8	12	20
Over 超过	Up to 以下	Permissible deviations of total Run-out in radial direction 跳动公差 (最大)		
—	125	0.015	0.015	0.015
125	200	0.025	0.020	0.020
200	315	0.035	0.025	0.020
315	400	—	0.035	0.025
400	500	—	0.045	0.035
500	630	—	0.050	0.040
630	800	—	—	0.050
800	1000	—	—	0.065

表 A-95：丝杠轴轴线的半径方向全跳动(C3)

Table A-95 : Total Run-out in radial direction of Screw Shaft related to the centerline of Screw Shaft (C3) Unit(单位):mm

		Shaft nominal diameter 丝杠轴公称外径		
		—	8	12
Over/超过		—	8	12
Up to/以下		8	12	20
Over 超过	Up to 以下	Permissible deviations of total Run-out in radial direction 跳动公差 (最大)		
—	125	0.025	0.025	0.020
125	200	0.035	0.035	0.025
200	315	0.050	0.040	0.030
315	400	0.060	0.050	0.040
400	500	—	0.065	0.050
500	630	—	0.070	0.055
630	800	—	—	0.070
800	1000	—	—	0.095

表 A-94：丝杠轴轴线的半径方向全跳动(C1)

Table A-94 : Total Run-out in radial direction of Screw Shaft related to the centerline of Screw Shaft (C1) Unit(单位):mm

		Shaft nominal diameter 丝杠轴公称外径		
		—	8	12
Over/超过		—	8	12
Up to/以下		8	12	20
Over 超过	Up to 以下	Permissible deviations of total Run-out in radial direction 跳动公差 (最大)		
—	125	0.020	0.020	0.015
125	200	0.030	0.025	0.020
200	315	0.040	0.030	0.025
315	400	0.045	0.040	0.030
400	500	—	0.050	0.040
500	630	—	0.060	0.045
630	800	—	—	0.060
800	1000	—	—	0.075

表 A-96：丝杠轴轴线的半径方向全跳动(C5)

Table A-96 : Total Run-out in radial direction of Screw Shaft related to the centerline of Screw Shaft (C5) Unit(单位):mm

		Shaft nominal diameter 丝杠轴公称外径		
		—	8	12
Over/超过		—	8	12
Up to/以下		8	12	20
Over 超过	Up to 以下	Permissible deviations of total Run-out in radial direction 跳动公差 (最大)		
—	125	0.035	0.035	0.035
125	200	0.050	0.040	0.040
200	315	0.065	0.055	0.045
315	400	0.075	0.065	0.055
400	500	—	0.080	0.060
500	630	—	0.090	0.075
630	800	—	—	0.090
800	1000	—	—	0.120

表 A-97：丝杠轴轴线的半径方向全跳动(C7)

Table A-97: Total Run-out in radial direction of Screw Shaft related to the centerline of Screw Shaft (C7) Unit(单位):mm

Shaft total length 丝杠轴总长		Shaft nominal diameter 丝杠轴公称外径		
		Over/超过	8	12
Up to/以下		8	12	20
Over 超过	Up to 以下	Permissible deviations of total Run-out in radial direction 跳动公差 (最大)		
—	125	0.060	0.055	0.055
125	200	0.075	0.065	0.060
200	315	0.100	0.080	0.070
315	400	—	0.100	0.080
400	500	—	0.120	0.095
500	630	—	0.150	0.110
630	800	—	—	0.140
800	1000	—	—	0.170

表 A-98：丝杠轴轴线的半径方向全跳动(C10)

Table A-98: Total Run-out in radial direction of Screw Shaft related to the centerline of Screw Shaft (C10) Unit(单位):mm

Shaft total length 丝杠轴总长		Shaft nominal diameter 丝杠轴公称外径		
		Over/超过	8	12
Up to/以下		8	12	20
Over 超过	Up to 以下	Permissible deviations of total Run-out in radial direction 跳动公差 (最大)		
—	125	0.100	0.095	0.090
125	200	0.140	0.120	0.110
200	315	0.210	0.160	0.130
315	400	—	0.210	0.160
400	500	—	0.270	0.200
500	630	—	0.350	0.250
630	800	—	0.460	0.320
800	1000	—	—	0.420

注) Ct7、Ct10规格时, 有时会根据JIS B1192-2013标准, 采用基于细长比的全跳动规格(下表)。

Note) In case of Ct7, Ct10 grade, KSS may use the standard of Total Run-out based on slenderness ratio, which conforms to JIS B1192-2013.

Slenderness ratio 细长比		Total Run-out 全跳动	
Over / 超过	Up to / 以下	Ct7	Ct10
—	40	0.080	0.160
40	60	0.120	0.240
60	80	0.200	0.400
80	100	0.320	0.640

细长比 / Slenderness ratio =  $l_u/d_o$

$l_u$ : 螺纹部有效长度 / Useful travel (mm)

$d_o$ : 丝杠轴公称外径 / Nominal diameter of Ball Screw (mm)

## 滚珠丝杠安装部精度的测量方法

### Measuring method of Ball Screw Run-out and location tolerances

#### ●相对于丝杠轴螺纹槽面的支撑部外径的半径方向圆跳动 (表 A-88)

用V形块支撑丝杠轴两端, 一边使丝杠轴旋转, 一边读取测量头接触螺母外周面的千分表刻度。测量作业在支撑部附近的2处进行。此外, 直接用千分表测量支撑部外径时, 用两个中心孔支撑丝杠轴进行测量。

#### ●Radial Run-out of Bearing seat related to the centerline of screw groove (Table A-88)

Place the Ball Screw in identical V-blocks at both Bearing seat. Place the dial gauge perpendicular to the Nut cylindrical surface. Rotate Screw Shaft slowly and record the dial gauge readings. Measurement should be done at near both ends of threaded part. Some cases, this measurement will be done by both centerhole support, and directly measured on Bearing seat.

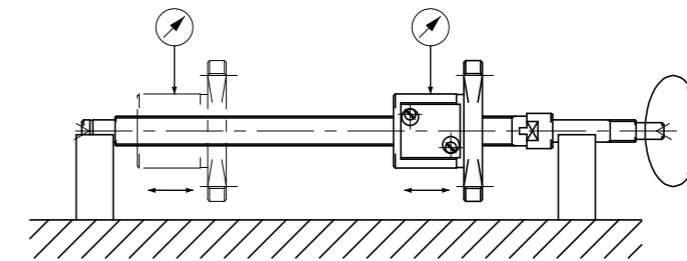

#### ●相对于丝杠轴支撑部轴线的零件安装部的半径方向圆跳动 (表A-88)

用V形块支撑丝杠轴两端, 一边使丝杠轴旋转, 一边读取测量头接触零件安装部的千分表刻度。

#### ●Radial Run-out of journal diameter related to the Bearing seat (Table A-88)

Place the Ball Screw in identical V-blocks at both Bearing seats. Place the dial gauge perpendicular to the journal cylindrical surface. Rotate the Screw Shaft slowly and record the dial gauge readings.

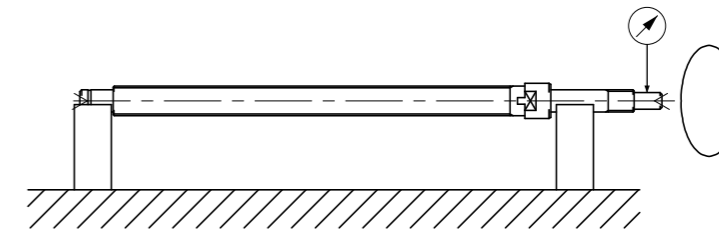

#### ●相对于丝杠轴支撑部轴线的支撑部端面的垂直度 (表 A-89)

用两个中心孔支撑丝杠轴两端, 一边使丝杠轴旋转, 一边读取测量头接触支撑部端面的千分表刻度。

#### ●Axial Run-out (Perpendicularity) of shaft (Bearing) face related to the centerline of the Bearing seat (Table A-89)

Support a Screw Shaft at both centers. Place the dial gauge perpendicular to the end face of the journal. Rotate the Screw Shaft slowly and record the dial gauge readings.

\*\*图纸中的标示以支撑部外周面为基准, 但由于支撑部外周面以中心孔为基准进行了加工, 因此与用V形块支撑支撑部外周面时相同。

\*\*This method is equivalent to the one, which is supported at both Bearing seats, because Bearing seats are ground related to both centers.

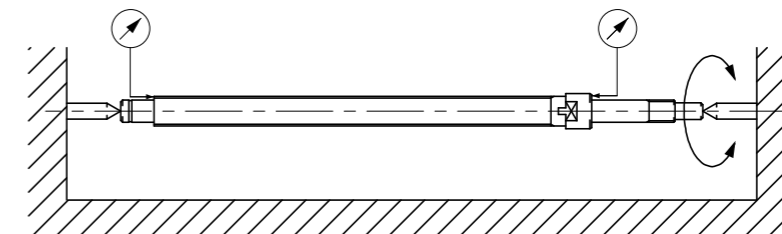

●相对于丝杠轴轴线的螺母基准端面或法兰安装面的垂直度 (表 A-90)

用两个中心孔支撑丝杠轴两端, 一边使轴与螺母一起旋转, 一边读取测量头接触螺母法兰端面的千分表刻度。

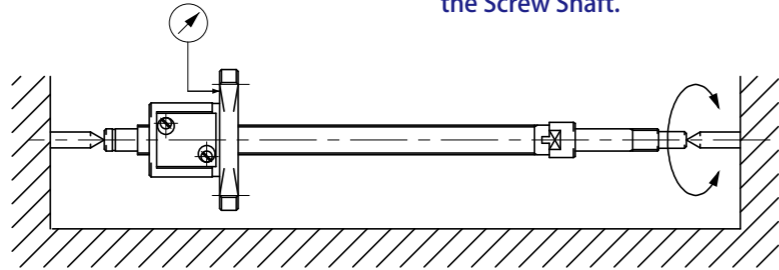

●Axial Run-out (Perpendicularity) of Ball Nut location face related to the centerline of Screw Shaft (Table A-90)

Support the Ball Screw at both centers. Place the dial gauge perpendicular to the flange face. Rotate the Screw Shaft with Ball Nut slowly and record the dial gauge readings. Secure the Ball Nut against rotation on the Screw Shaft.

●相对于丝杠轴轴线的螺母外周面的半径方向圆跳动 (表 A-91)

用V形块支撑丝杠轴螺母附近的外周面, 一边使螺母旋转, 一边读取测量头接触螺母外周面的千分表刻度。

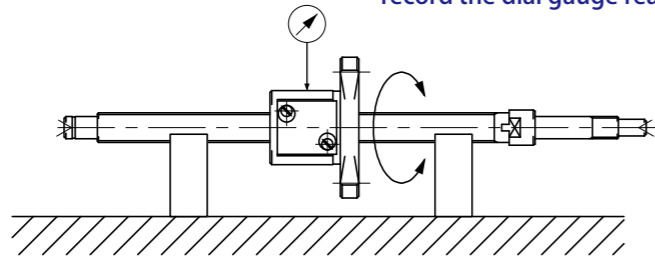

●Radial Run-out of Ball Nut location diameter related to the centerline of Screw Shaft (Table A-91)

Place the Ball Screw on V-blocks at adjacent sides of the Ball Nut. Place the dial gauge perpendicular to the cylindrical surface of Ball Nut. Secure the Screw Shaft against rotation of Ball Nut. Rotate Ball Nut slowly and record the dial gauge readings.

●丝杠轴轴线的半径方向全跳动 (表 A-93~98)

用两个中心孔或V形块支撑丝杠轴两端, 一边使丝杠轴旋转, 一边读取测量头接触丝杠轴外周面或螺母外周面的千分表刻度。测量作业含整个范围, 选多处进行。

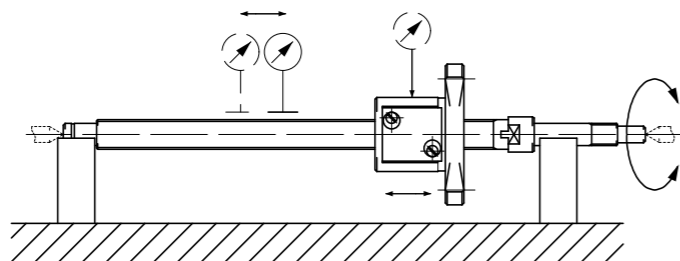

●Total Run-out in radial direction of Screw Shaft related to the centerline of Screw Shaft (Table A-93~98)

Place the Ball Screw in identical V-blocks at both Bearing seats, or support the Ball Screw at both centers. Place the dial gauge with measuring shoe at the several points over the full thread length. Rotate the Screw Shaft slowly and record the dial gauge readings. Maximum value of measurement should be the Total Run-out.

## 材质和热处理、硬度

### Material and Heat treatment, Surface hardness

KSS滚珠丝杠的标准材质、热处理和硬度如表A-99、100所示。表中数值可能会因系列及型号不同而略有差异, 请参照本公司出示的规格图。

Standard material of KSS Ball Screws, Heat treatment and Surface hardness are shown in table A-99, 100. However, they vary depending on series or model number. Please refer to KSS drawings.

表 A-99 : 一般产品的材质和热处理、硬度

Table A-99 : Material, Heat treatment & Surface hardness for regular items

	Material 材质	Heat treatment 热处理	Surface hardness 表面硬度
Screw Shaft 丝杠轴	SCM415	Carburizing and quenching 渗碳淬火	HRC 58-62
Nut 螺母	SCM415	Carburizing and quenching 渗碳淬火	HRC 58-62

注) 表中所示硬度为滚珠丝杠部的表面硬度。

Note) Hardness on table shows surface hardness of thread part.

表 A-100 : 不锈钢产品的材质和热处理、硬度

Table A-100 : Material, Heat treatment & Surface hardness for stainless steel items

	Material 材质	Heat treatment 热处理	Surface hardness 表面硬度
Screw Shaft 丝杠轴	SUS440C	Quenching and tempering 淬火、回火	HRC min.55 HRC 55以上
Nut 螺母	SUS440C	Quenching and tempering 淬火、回火	HRC min.55 HRC 55以上

注) 表中所示硬度为滚珠丝杠部的表面硬度。

Note) Hardness on table shows surface hardness of thread part.

## 许用轴向负载 Permissible Axial load

建议尽量在有拉伸负载作用于丝杠轴的条件下使用。但根据使用条件,可能会有压缩负载作用,此时应避免丝杠轴发生压曲。

尤其在安装间距较小时,无论采用何种安装方法,都会受到许用拉伸应力或压缩负载及基本额定静负载Coa的限制。压曲负载、许用拉伸和许用压缩负载可用下式求出。

It is recommended that Ball Screw Shafts be used almost exclusively under tension load conditions. However, in some applications, compression loads may exist, and under such conditions it must be determined that Shaft buckling will not occur.

Also, when the mounting span distance is short, there is a restriction on the permissible tension or compression load and the Basic Static Load Rating Coa unrelated to mounting.

Buckling load, permissible tension and permissible compression load can be calculated below.

### ●相对于压曲的许用压缩负载的计算公式

Permissible compression load calculation for buckling

$$P = \alpha \times \frac{n\pi^2 E \cdot I}{L^2} \quad \text{N (kgf)} \quad \text{欧拉公式 (Formula for Euler)}$$

$\alpha$  : 安全系数 (Safety Factor) 0.5

E : 杨氏模量 (Young's modulus)  $2.08 \times 10^5 \text{ N/mm}^2 \text{ (MPa)} \{21,200\text{kgf/mm}^2\}$

I : 丝杠轴截面的最小惯性矩 (Screw Shaft minimum moment of inertia of area)

$$I = \frac{\pi}{64} d^4 \quad \text{mm}^4$$

d : 丝杠轴底径 (Screw Shaft Root diameter) mm

L : 安装间距 (Mounting span distance) mm

n : 取决于滚珠丝杠安装方法的系数 (Factor for Ball Screw mounting method)

支撑-支撑 (Supported-Supported)  $n=1$

固定-支撑 (Fixed-Supported)  $n=2$

固定-固定 (Fixed-Fixed)  $n=4$

固定-自由 (Fixed-Free)  $n=1/4$

### ●相对于丝杠轴屈服应力的许用拉伸、压缩负载的计算公式

Permissible tension, compression load calculation for Screw Shaft yield stress

$$P = \sigma \times A \quad \text{N (kgf)}$$

$\sigma$  : 许用应力 (Permissible stress)  $98\text{N/mm}^2 \text{ (MPa)} \{10\text{kgf/mm}^2\}$

A : 丝杠轴的最小截面积 (Screw Shaft minimum section area)

$$A = \frac{\pi}{4} d^2 \quad \text{mm}^2$$

d : 丝杠轴底径 (Screw Shaft Root diameter) mm

## 许用转速 Permissible speed

丝杠轴的安装方法决定了旋转丝杠轴的极限转速。转速接近极限值时会引起共振,导致丝杠轴无法运行。

此外,无论采用何种安装方法,滚珠丝杠都存在会导致循环部损坏的极限转速。

For Screw Shaft rotation, the mounting method determines the established rotation limits. When this value is approached, resonance phenomenon can occur, and operation becomes impossible. There is also rotation limit which causes damages to recirculating parts. This limit is unrelated to mounting methods.

### ●相对于临界速度的许用转速的计算公式

Permissible speed calculation for critical speed

$$N = \beta \times \frac{60 \cdot \lambda^2}{2\pi} \times \sqrt{\frac{E \cdot I \cdot g}{\gamma \cdot A \cdot L^4}} \quad \text{min}^{-1} \text{ (rpm)}$$

$\beta$  : 安全系数 (Safety Factor) 0.8

E : 杨氏模量 (Young's modulus)  $2.08 \times 10^5 \text{ N/mm}^2 \text{ (MPa)} \{21,200\text{kgf/mm}^2\}$

I : 丝杠轴截面的最小惯性矩 (Screw Shaft minimum moment of inertia of area)

$$I = \frac{\pi}{64} d^4 \quad \text{mm}^4$$

d : 丝杠轴底径 (Screw Shaft Root diameter) mm

g : 重力加速度 (Gravity acceleration)  $9.8 \times 10^3 \text{ mm/sec}^2$

$\gamma$  : 材料的比重 (Material specific gravity)  $7.7 \times 10^{-5} \text{ N/mm}^3 \{7.85 \times 10^{-6} \text{ kgf/mm}^3\}$

L : 安装间距 (Mounting span distance) mm

A : 丝杠轴的最小截面积 (Screw Shaft minimum section area)

$$A = \frac{\pi}{4} d^2 \quad \text{mm}^2$$

$\lambda$  : 取决于滚珠丝杠安装方法的系数 (Factor for Ball Screw mounting method)

支撑-支撑 (Supported-Supported)  $\lambda = \pi$

固定-支撑 (Fixed-Supported)  $\lambda = 3.927$

固定-固定 (Fixed-Fixed)  $\lambda = 4.730$

固定-自由 (Fixed-Free)  $\lambda = 1.875$

### ●相对于循环部损坏的极限转速

关于相对于循环部损坏的极限转速,一般多根据滚珠丝杠的钢珠速度dn值(丝杠轴公称外径×转速)来设定上限值,但对于像KSS滚珠丝杠这样的微型滚珠丝杠,dn值则不适用。KSS滚珠丝杠的循环部损坏极限转速为3,500~4,000rpm左右。该数值会因使用条件及环境而异,详情请垂询本公司。

### ●Rotation limits for damage on recirculating parts

Generally, regarding critical speed for damage on recirculating parts, limitation is established by dn value, which is multiplied Shaft nominal diameter of revolution, but dn value cannot be applied to Miniature Ball Screws. For KSS Ball Screws, please consider rotation limits by damage on recirculating parts as 3,500 to 4,000rpm. This value varies depending on operating conditions and environment. Please inquire KSS for details.



## 滚珠丝杠的安装方法 Ball Screw mounting methods

滚珠丝杠的典型安装方法如图A-101所示。由于安装方法会影响相对于压曲的许用轴向负载、以及相对于临界速度的许用转速，因此请在设计强度和转速时予以考虑。

Typical Ball Screw's mounting methods are shown in Fig. A-101. Mounting configuration affects permissible Axial load in relation to buckling, as well as permissible speed in relation to critical speed. Please refer to below when studying strength and speed.

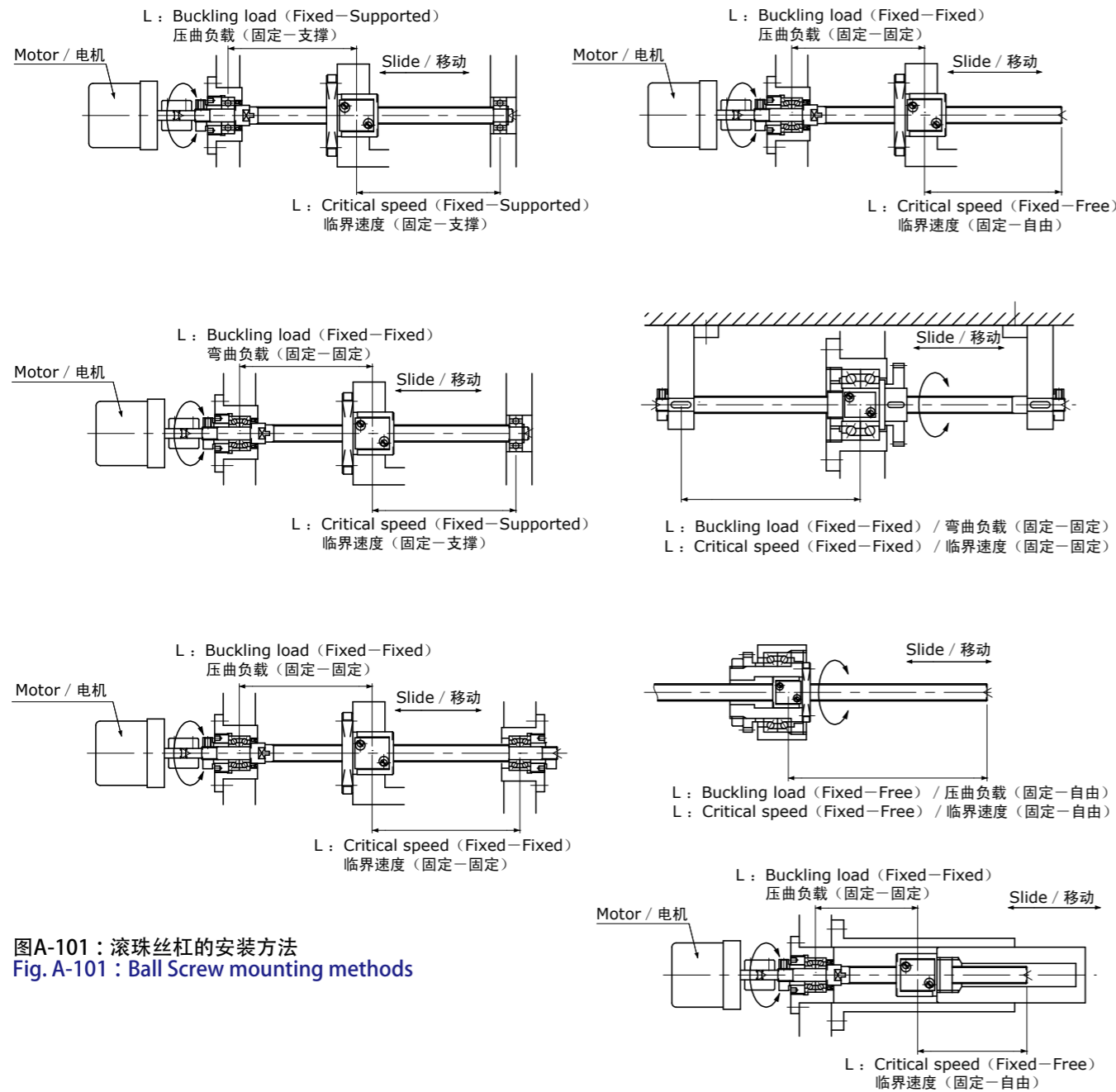

图A-101：滚珠丝杠的安装方法  
Fig. A-101 : Ball Screw mounting methods

## 轴向间隙和预压 Axial play and Preload

通常，普通的单螺母滚珠丝杠的丝杠轴和螺母之间存在微小的轴向间隙。因此，当单螺母滚珠丝杠上有轴向负载作用时，上述轴向间隙和轴向负载所产生的弹性位移量的和就会导致间隙变大，形成齿隙。为消除这样的齿隙，应使滚珠丝杠的轴向间隙为负，即采用预先向丝杠轴和螺母间施加弹性变形，也就是“预压”的方法。

For standard Single Nut Ball Screws under normal conditions, a slight Axial play exists between the Screw Shaft and Nut. Consequently, when Axial loads act on Single Nut Ball Screws, total amount of Axial play and Elastic displacement due to Axial load becomes backlash. In order to prevent this backlash in Ball Screws, the Axial play can be reduced to a negative value. That is what we call "Preload", which is the method of causing Elastic deformation to the Balls between the Screw Shaft and Nut in advance.

### ● 轴向间隙

KSS滚珠丝杠的间隙符号和轴向间隙的许用值如表A-102所示。  
滚珠丝杠的精度等级和间隙符号的组合如表A-103所示。

### ● Axial play

Symbol and permissible value for Axial play are shown in Table A-102.  
Combination of accuracy grade and symbol are shown in Table A-103.

表 A-102：间隙符号和轴向间隙的许用值  
Table A-102 : Symbol and permissible value for Axial play

Symbol 间隙符号	0	02	05	20	50
Axial play 轴向间隙	0 (Preloading) 0 (预压)	0.002 max. 0.002以下	0.005 max. 0.005以下	0.02 max. 0.02以下	0.05 max. 0.05以下

Unit(单位): mm

表 A-103：精度等级和间隙符号的组合  
Table A-103 : Combination of accuracy grade and Axial play

Symbol 间隙符号	0	02	05	20	50
Accuracy grade 精度等级					
C0	C0-0	—	—	—	—
C1	C1-0	C1-02	—	—	—
C3	C3-0	C3-02	C3-05	C3-20	C3-50
C5	—	—	C5-05	C5-20	C5-50
C7	—	—	—	C7-20	C7-50
C10	—	—	—	C10-20	C10-50

注) 希望采用上述以外的组合时，请垂询本公司。  
Note) When combinations other than the above are requested, please inquire KSS.

### ● 预压的效果

使用预压,不仅可以消除滚珠丝杠的轴向间隙,还可减少由轴向负载引起的轴向位移量,提高刚性。

图A-104表示间隙规格滚珠丝杠和预压(无间隙)规格滚珠丝杠的轴向负载引起的弹性位移量的不同(理论值)。可以看出,通过预压,可减少(刚性提高)弹性位移量。

### ● Preload effect

Preload is not only used for removing Axial play, it also has the effect of reducing the amount of Axial displacement due to Axial load, and improving the Rigidity in Ball Screws. Fig. A-104 shows the difference of the amount of Elastic displacement (theoretical value) regarding Ball Screw with Axial play and Ball Screw with Preload under the Axial load.

图A-104 : 间隙规格和预压规格的弹性位移曲线

Fig. A-104 : Elastic displacement curve comparison between Backlash type and Preload type

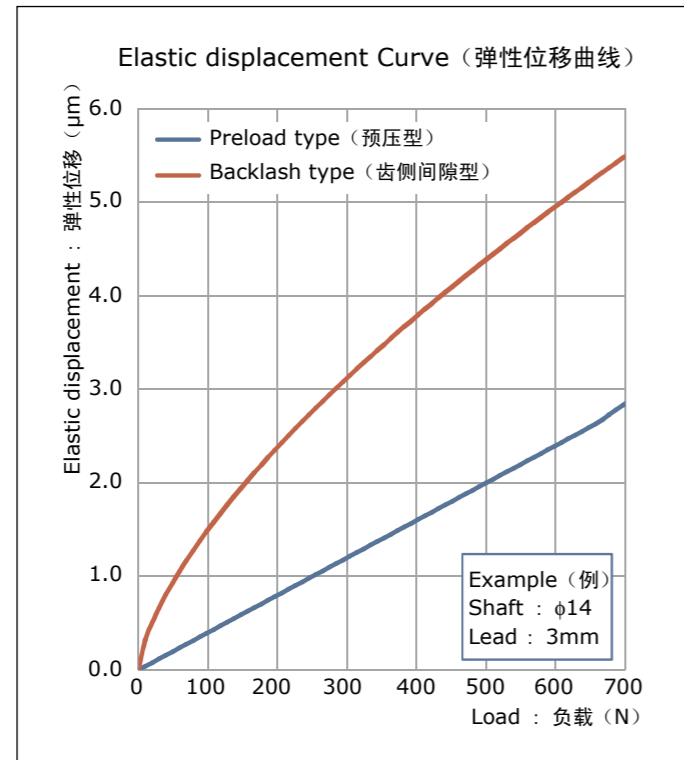

### ● 适当的预压量

预压量应该由所需刚性或许用齿侧间隙决定,但施加预压后,可能会产生以下影响:

- 1) 动扭矩增大
- 2) 因发热、温度上升而导致定位精度降低
- 3) 缩短使用寿命

因此,应尽可能设定较低的预压量。

### ● Proper amount of Preload

Although the amount of Preload should be determined by the required Rigidity and the permissible amount of backlash, when setting Preload, there are some concerning issues as follows.

- 1) Increased Dynamic Drag Torque
- 2) Heat generation lowering of positioning accuracy due to the temperature rise.
- 3) Shortened life

Therefore, it is advisable to establish the amount of Preload at the lowest possible limits.

### ● 预压的方法

滚珠丝杠一般采用在2个螺母之间插入隔片(填隙片)的预压方法,即双螺母预压法。KSS滚珠丝杠充分发挥微型滚珠丝杠的特点,采用插入略微大于丝杠轴和螺母间隙的钢珠的预压方法,即“大号钢珠预压”法。利用该方法,只需1个螺母即可完全消除间隙,可保持紧凑结构。另外,通过每隔一处使用间隔钢珠(略小于施加预压的大号钢珠),避免了动作性能下降。

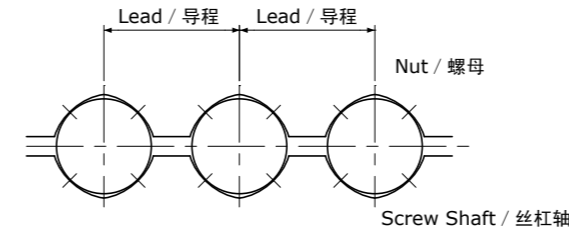

图A-105 : 使用大号钢珠的预压状态  
Fig. A-105 : Preload by oversized Balls

### ● Preload methods

Generally, a method of Double Nut Preload by inserting a spacer between two Nuts is adopted. KSS Ball Screw adopts 「Oversized Ball Preload」 by inserting Balls slightly bigger than space between Screw Shaft and Nut. As a result, it can eliminate Axial play even with a Single Nut and it is possible to maintain compact. Moreover, operating performance will never be deteriorated by using spacer Balls (Balls with slightly smaller diameter than those of the oversize Balls) alternatively with oversize Balls.

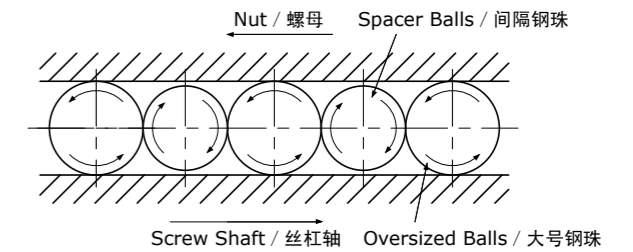

图A-106 : 间隔钢珠  
Fig. A-106 : Spacer Balls

### ● 预压的管理方法

直接测量并管理滚珠丝杠的预压量相当困难。因此,通常将滚珠丝杠的预压换算成预压动扭矩,通过测量该动扭矩来管理预压。预压动扭矩的值标示在规格图中,与客户协商决定。为了管理预压量(轴向间隙必须为0),预压动扭矩始终在一定的条件下进行测量。因此,润滑条件及使用条件的不同的机械会导致动扭矩产生差异,敬请注意。此外,启动扭矩(驱动滚珠丝杠时的扭矩)会略大于动扭矩,敬请注意。

### ● Preload control

It is difficult to control Preload amount by measuring. Therefore, Preload of Ball Screw is controlled by measuring Preload Dynamic Drag Torque, which is converted from Preload amount. Amount of Preload Dynamic Drag Torque is decided with customers by specification drawing. Preload Dynamic Drag Torque is measured under specific condition to verify the amount of Axial play is 0. Dynamic Drag Torque installed actual machine will vary depending on lubricating condition, load condition and so on. Starting torque (Torque for starting Ball Screw) is slightly bigger than Dynamic Drag Torque.

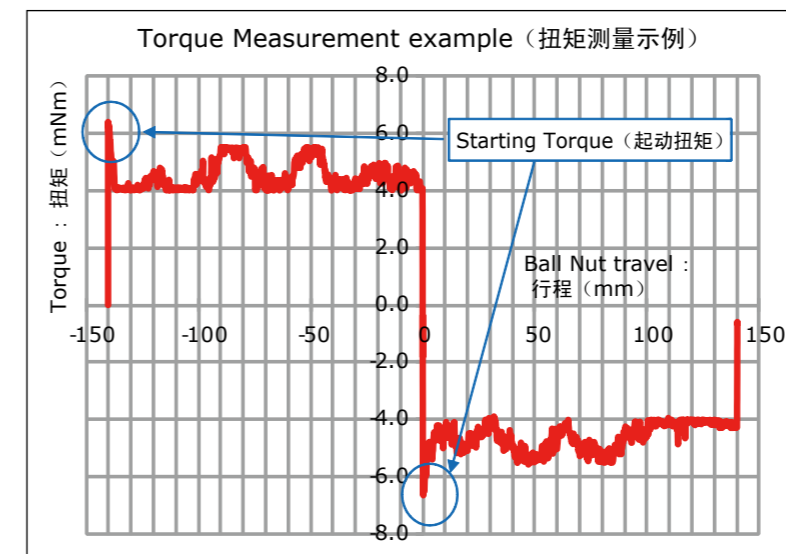

\*为便于说明,图中所示的扭矩波动比实际有所夸大。  
\*Torque wave in this diagram is exaggerated for explanation.

图A-107 : 动扭矩测量示例  
Fig. A-107 : Dynamic Drag Torque measurement

## 进给丝杠轴系统的刚性 Rigidity in feed screw system

在精密机械中, 为了提高进给丝杠的定位精度、增强抗负载刚性, 必须对进给丝杠轴系统整体的刚性进行探讨。  
进给丝杠轴系统的刚性如下所示。

In precision machinery, to improve positioning accuracy of the feed screws or to increase Rigidity for load, the Rigidity of the entire feed screw system must be examined. Feed screw system Rigidity is as follows.

$$\frac{1}{K} = \frac{1}{K_1} + \frac{1}{K_2} + \frac{1}{K_3} + \frac{1}{K_4} \quad \text{N/m} \{ \text{kgf/m} \}$$

K : 进给丝杠轴系统整体的刚性 (Total Rigidity of feed screw system)  
K<sub>1</sub> : 丝杠轴的刚性 (Screw Shaft Rigidity)  
K<sub>2</sub> : 螺母的刚性 (Nut Rigidity)  
K<sub>3</sub> : 支撑轴承的刚性 (Support Bearing Rigidity)  
K<sub>4</sub> : 螺母和轴承安装部的刚性 (Nut, Bearing fitting part Rigidity)

N/m {kgf/m}  
N/m {kgf/m}  
N/m {kgf/m}  
N/m {kgf/m}  
N/m {kgf/m}

### ● 进给丝杠轴系统整体的刚性 Total Rigidity of feed screw system K

$$K = \frac{F_a}{\delta} \quad \text{N/m} \{ \text{kgf/m} \}$$

F<sub>a</sub> : 进给丝杠轴系统承受的轴向负载 (Axial load applied to feed screw system) N {kgf}  
δ : 进给丝杠轴系统的弹性位移量 (Elastic displacement of feed screw system) m

### ● 丝杠轴的刚性 Screw Shaft Rigidity K<sub>1</sub>

(1) 普通安装时(轴向为固定—自由时) (图A-108)

In case of general mounting (Fixed-Free in axial direction) (Fig. A-108)

$$K_1 = \frac{A \cdot E}{r} \times 10^{-3} \quad \text{N/m} \{ \text{kgf/m} \}$$

(2) 两端固定时(图A-109)

In case of Fixed-Fixed mounting in axial direction (Fig. A-109)

$$K_1 = \frac{A \cdot E \cdot L}{r (L-r)} \times 10^{-3} \quad \text{N/m} \{ \text{kgf/m} \}$$

r=L/2时将产生最大轴向位移, 刚性如下所示。

The max. axial displacement occurs when r = L/2. The formula is as follows.

$$K_1 = \frac{4 \cdot A \cdot E}{L} \times 10^{-3} \quad \text{N/m} \{ \text{kgf/m} \}$$

A : 丝杠轴的最小截面积 (Screw Shaft minimum section area)

$$A = \frac{\pi}{4} d^2 \quad \text{mm}^2$$

d : 丝杠轴底径 (Screw Shaft Root diameter) mm

E : 杨氏模量 (Young's modulus)

2.08 × 10<sup>5</sup> N/mm<sup>2</sup> (MPa) {21,200kgf/mm<sup>2</sup>}

l : 轴向固定点和螺母中央的距离 (Axial distance between fixed point & Nut center) mm

L : 安装间距 (Mounting span distance) mm

因此, 因轴向负载F<sub>a</sub>引起的丝杠轴弹性位移量δ可由下式求出。

Accordingly, the amount of Screw Shaft Elastic displacement δ due to Axial load F<sub>a</sub> is as follows.

$$\delta = \frac{F_a}{K_1} \quad \text{m}$$

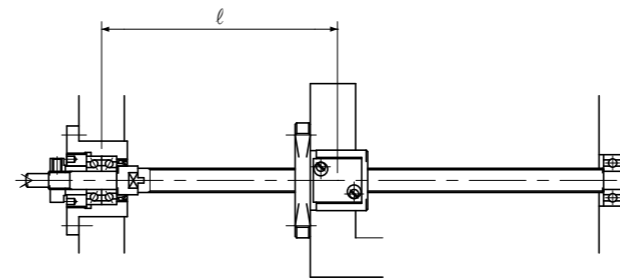

图A-108 : 轴向为固定—自由时  
Fig. A-108 : Fixed-Free in axial direction

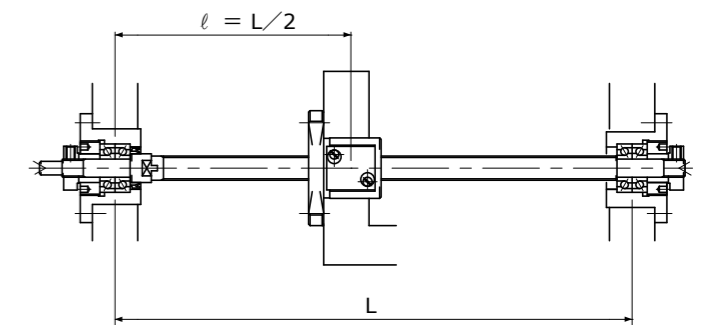

图A-109 : 两端固定时  
Fig. A-109 : Fixed-Fixed in axial direction

## ●螺母的刚性 $K_2$

### (1) 单螺母间隙规格的刚性

基本额定动负载Ca的30%的轴向负载作用时, 螺母的理论静刚性值 $K_2$ 请见“尺寸表”。轴向负载非基本额定动负载Ca的30%时, 请用下式计算。关于尺寸表中未标出的型号的理论静刚性值, 请垂询本公司。

$$K'_2 = K_2 \times \left( \frac{Fa}{0.3Ca} \right)^{1/3} \text{ N/}\square\text{m \{kgf/}\square\text{m\}}$$

$K_2$  : 尺寸表中标出的螺母刚性值 (Nut Rigidity in dimension table)     $\text{N/}\square\text{m \{kgf/}\square\text{m\}}$   
 $Fa$  : 轴向负载 (Axial load)     $\text{N \{kgf\}}$   
 $Ca$  : 基本额定动负载 (Basic Dynamic Load Rating)     $\text{N \{kgf\}}$

### (2) 预压规格(零间隙规格)的刚性

施加相当于基本额定动负载Ca的5%(双螺母为10%)的预压负载时的螺母理论静刚性值 $K_2$ 请见“尺寸表”。预压负载与上述不同时, 可用下式计算, 预压规格(零间隙规格)时, 刚性值还会因预压动扭矩而变化。详情请垂询本公司。如有需要, 本公司可为您计算尺寸表中标出的型号的理论静刚性值。

$$K'_2 = K_2 \times \left( \frac{Ga}{0.05Ca} \right)^{1/3} \text{ N/}\square\text{m \{kgf/}\square\text{m\}}$$

$K_2$  : 尺寸表中标出的螺母刚性值 (Nut Rigidity in dimension table)     $\text{N/}\square\text{m \{kgf/}\square\text{m\}}$   
 $Ga$  : 预压负载 (Preload amount)     $\text{N \{kgf\}}$   
 $Ca$  : 基本额定动负载 (Basic Dynamic Load Rating)     $\text{N \{kgf\}}$

## ●Nut Rigidity $K_2$

### (1) Rigidity of Single Nut with backlash

The theoretical static Rigidity  $K_2$  of the Nut under an Axial load equivalent to 30% of the Basic Dynamic Load Rating Ca is described in dimension table. For Axial loads which are not 30% of the Basic Dynamic Load Rating Ca, please use the following formula. Please inquire KSS regarding theoretical Static Rigidity of model types which are not in dimension table.

### (2) Rigidity of preloaded Ball Nut

The theoretical static Rigidity  $K_2$  under a Preload equivalent to 5% (10% for Double Nut) of the Basic Dynamic Load Rating Ca is described in dimension table. For Preload amounts other than the above, please use the following formula. In case of Preload type Ball Screws, Rigidity varies depending on the dispersion of Preload Dynamic Drag Torque. Therefore, please inquire KSS for details. KSS will calculate theoretical Static Rigidity of required Nut models, which are not in the dimension table.

### 单螺母预压规格 (Single Nut with oversized Ball Preload)

## ●支撑轴承的刚性 $K_3$

支撑轴承的刚性因所用轴承及其预压量而异, 详情请洽询轴承制造商。

## ●螺母和轴承安装部的刚性 $K_4$

螺母安装部及轴承安装部等的刚性因装置的结构和设计而异, 本公司未作具体规定, 请尽量采用高刚性设计。

## ●丝杠轴的扭曲刚性

与轴向位移相比, 扭曲造成的定位误差值很小, 需要考虑时, 可由下式求出。

$$\theta = \frac{32TL}{\pi Gd^4} \times \frac{180}{\pi} \times 10 \quad \text{deg}$$

$\theta$  : 扭力矩引起的扭曲角 (Torsion angle due to torsion moment)     $\text{deg}$   
 $T$  : 扭力矩 (Torsion moment)     $\text{N}\cdot\text{cm \{kgf}\cdot\text{cm\}}$   
 $L$  : 螺母与轴端支撑部的距离 (Distance between Nut & Shaft end support)     $\text{mm}$   
 $G$  : 切变模量 (Modulus of Rigidity)     $8.3 \times 10^4 \text{ N/mm}^2 \text{ (MPa) \{8,500 kgf/mm}^2\}$   
 $d$  : 丝杠轴底径 (Screw Shaft Root diameter)     $\text{mm}$

因扭曲角而引起的轴向位移量 $\delta a$ 如下所示。

Amount of axial displacement  $\delta a$  due to torsion angle is as follows.

$$\delta a = r \times \frac{\theta}{360} \times 10^3 \quad \square\text{m}$$

$r$ : 导程 (Lead)     $\text{mm}$

## ●Support Bearing Rigidity $K_3$

Support Bearing Rigidity varies depending on the type of Bearing and amount of Preload. Please inquire Bearing manufacturers.

## ●Nut, Bearing fitting part Rigidity $K_4$

Rigidity of Nut mounting part and Bearing mounting part vary depending on machine structure and design. KSS cannot mention the details but a design of high Rigidity must be considered.

## ●Screw Shaft torsion Rigidity

For positioning error due to torsion, this error is a relatively small compared to axial displacement. However, if investigation is required, the following formula may be used for calculation.

## 基本额定负载和基本额定寿命 Basic Load Rating and Basic Rating Life

### ●基本额定动负载Ca与基本额定寿命

滚珠丝杠的额定寿命是指一组相同的滚珠丝杠在相同的条件下运行时,其中90%的滚珠丝杠的滚珠槽及滚珠表面没有因滚动接触而导致疲劳剥落的状态下的总转数。基本额定动负载Ca是指额定寿命为100万转的轴向负载,该值以Ca标记在尺寸表中。滚珠丝杠的额定寿命L<sub>10</sub>可利用该基本额定动负载Ca的值,通过下式推算。

$$L_{10} = \left( \frac{Ca}{f \cdot Fa} \right)^3 \times 10^6 \text{ rev}$$

不用总转数而用时间L<sub>10h</sub>或行走距离L<sub>10d</sub>来表示额定寿命时,可通过以下公式计算。

$$L_{10h} = \left( \frac{1}{60 \cdot N} \right) \times L_{10} \text{ 时间 (hours)}$$

$$L_{10d} = \left( \frac{r}{10^6} \right) \times L_{10} \text{ km}$$

### ●Basic Dynamic Load Rating Ca and Basic Rating Life

The Basic Rating Life of Ball Screws means the total number of revolutions which 90% of the Ball Screws can endure. Failure is indicated by flaking caused by rolling fatigue on the surface of grooves or Balls. These figures are valid when a group of the same type Ball Screws are operated individually under the same conditions. The Basic Dynamic Load Rating Ca is the Axial load for which the Basic Rating Life is 1,000,000 revolutions. These values are listed under Ca in the dimension tables. Ball Screw's Basic Rating Life L<sub>10</sub> can be estimated using Basic Dynamic Load Rating Ca in the following formula.

Also, in place of the total number of revolutions, the Basic Rating Life can be expressed in hours: L<sub>10h</sub> or traveled distance: L<sub>10d</sub>, and these can be calculated through the following formulas.

Ca : 基本额定动负载 (Basic Dynamic Load Rating)	N {kgf}
Fa : 轴向负载 (Axial load)	N {kgf}
N : 转速 (Revolution)	min <sup>-1</sup> {rpm}
r : 导程 (Lead)	mm
f : 负载系数 (Load factor)	
f = 1.0~1.2 几乎无振动、无冲击时 (for almost no vibration, no shock condition)	
f = 1.2~1.5 稍有振动、冲击时 (for slight vibration, shock condition)	
f = 1.5~3.0 有强烈振动、冲击时 (for severe vibration, shock condition)	

一般情况下,作用于设备的轴向负载并不固定,其运行方式可分为几种。此时,可通过下式求出平均轴向负载F<sub>am</sub>、平均转速N<sub>m</sub>,然后算出额定寿命。

Generally, Axial load on the most machine is not constant and it can be divided into several operating pattern. In this case, Basic Rating Life can be calculated to figure up average Axial load F<sub>am</sub>, average Revolution N<sub>m</sub> in the following formula.

Axial load 轴向负载 N {kgf}	Revolution 转速 min <sup>-1</sup> {rpm}	Working time 使用时间 %
Fa <sub>1</sub>	N <sub>1</sub>	t <sub>1</sub>
Fa <sub>2</sub>	N <sub>2</sub>	t <sub>2</sub>
Fa <sub>3</sub>	N <sub>3</sub>	t <sub>3</sub>

$$F_{am} = \left( \frac{Fa_1^3 \cdot N_1 \cdot t_1 + Fa_2^3 \cdot N_2 \cdot t_2 + Fa_3^3 \cdot N_3 \cdot t_3}{N_1 \cdot t_1 + N_2 \cdot t_2 + N_3 \cdot t_3} \right)^{1/3} \text{ N {kgf}}$$

$$N_m = \frac{N_1 \cdot t_1 + N_2 \cdot t_2 + N_3 \cdot t_3}{t_1 + t_2 + t_3} \text{ min}^{-1} \text{ {rpm}}$$

此外,轴向负载呈直线变化时的平均轴向负载F<sub>am</sub>也可通过下式近似求出。

$$F_{am} = \frac{Fa_{min} + 2 \cdot Fa_{max}}{3} \text{ N {kgf}}$$

Fa<sub>min</sub> : 最小轴向负载 (Minimum Axial load) N {kgf}

Fa<sub>max</sub> : 最大轴向负载 (Maximum Axial load) N {kgf}

注) 滚珠丝杠寿命的计算公式以润滑状态良好、无异物混入为前提,且是在无力矩负载以及径向负载作用的纯轴向负载下的计算公式。

Also, for Axial loads which vary linearly, the average Axial load F<sub>am</sub> can be calculated approximately using the following formula.

Note) As the Basic Rating Life varies due to lubricating conditions, and contaminations, Moment load or Radial load, etc., this should be considered a rough estimate only.

### ●基本额定静负载Coa

基本额定静负载Coa是指在承受最大应力的接触部,使钢珠的滚动面和钢珠的永久变形量的和为钢珠直径的1/10000的轴向静止负载。该值以Coa标记于尺寸表中。该基本额定静负载Coa的值用于探讨静止状态或转速非常低(10rpm以下)时的负载条件。上述的永久变形量在多数情况下不影响使用。此时,螺纹槽部的最大许用负载Fa<sub>max</sub>可由下式求出。

$$Fa_{max} = \frac{Coa}{f_s} \text{ N {kgf}}$$

f<sub>s</sub> : 静态安全系数 (Static safety factor)

f<sub>s</sub> = 1~2 正常运行时 (for normal operation)

f<sub>s</sub> = 2~3 有振动、冲击时 (for vibration, shock)

### ●Basic Static Load Rating Coa

The Basic Static Load Rating Coa is the Axial Static load at which the amount of permanent deformation (Ball + Raceway) occurring at the maximum stress contact point between the Ball and Raceway surfaces is 1/10,000 times the Ball diameter. These values are listed under Coa in the dimension tables. The Basic Static Load Rating Coa values apply to investigation of stationary state or extremely low Revolution load conditions (less than 10 rpm). However, in most cases the amount of permanent deformation causes absolutely no problems under the general conditions. The maximum permissible load Fa<sub>max</sub> for the screw groove can be found by using the following formula.

### ●硬度系数 Hardness coefficient

表面硬度小于HRC58时,需要对基本额定动负载Ca和基本额定静负载Coa进行补偿。通过下式进行补偿。

For Surface hardness of less than HRC58, the Basic Dynamic Load Rating Ca and the Basic Static Load Rating Coa must be adjusted. Adjustment is made by the following formula.

$$Ca' = f_h \cdot Ca \text{ (N)}$$

$$Coa' = f_{ho} \cdot Coa \text{ (N)}$$

f<sub>h</sub>, f<sub>ho</sub> : 硬度系数 (右图)

Hardness coefficient (See graph right)

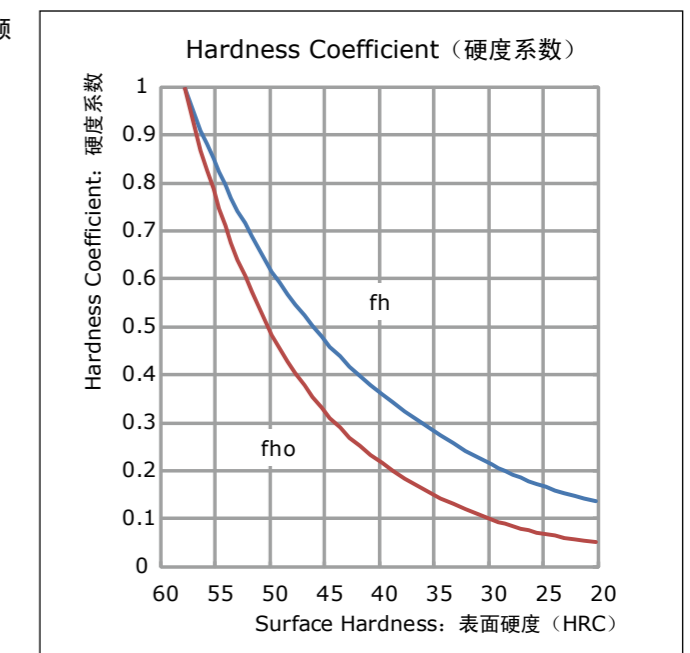

## 驱动扭矩 Driving Torque

进给丝杠系统的驱动扭矩T由下式求出。

The feed screw system Driving Torque T is expressed according to the following formula.

$$T = T_1 + T_2 + T_3 + T_4 \quad \text{N} \cdot \text{m} \{ \text{kgf} \cdot \text{cm} \}$$

T <sub>1</sub> : 加速产生的扭矩 (Acceleration Torque)	N·m {kgf·cm}
T <sub>2</sub> : 负载扭矩 (Load Torque)	N·m {kgf·cm}
T <sub>3</sub> : 预压动扭矩 (Preload Dynamic Drag Torque)	N·m {kgf·cm}
T <sub>4</sub> : 其他扭矩 (Additional Torque)	N·m {kgf·cm}

选择电机时需考虑进给丝杠系统产生的扭矩。

T<sub>1</sub>~T<sub>3</sub>可由下式求出。

When Motor selection, the feed screw system Driving Torque is needed.

T<sub>1</sub> ~ T<sub>3</sub> can be calculated by the following formula

### ● 加速产生的扭矩 Acceleration Torque T<sub>1</sub>

$$T_1 = \alpha \cdot I \quad \text{N} \cdot \text{m}$$

$$\alpha = \frac{2\pi N}{60 \cdot t} \quad \text{rad/sec}^2$$

$$I = I_w \cdot A^2 + I_s \cdot A^2 + I_A \cdot A^2 + I_B \quad \text{kg} \cdot \text{m}^2$$

$$I_w = m_w \times \left( \frac{r}{2\pi} \right)^2 \quad \text{kg} \cdot \text{m}^2$$

$$I_s = m_s \times \left( \frac{d^2}{8} \right) \quad \text{kg} \cdot \text{m}^2$$

$$m_s = \pi \left( \frac{d}{2} \right)^2 \times L \times \gamma \quad \text{kg}$$

α : 角加速度 (Angular acceleration)	rad/sec <sup>2</sup>
I : 惯性矩 (Inertia moment)	kg·m <sup>2</sup>
I <sub>w</sub> : 移动物的电机轴换算的惯性矩 (Inertia moment of moving object by Motor axial conversion)	kg·m <sup>2</sup>
I <sub>s</sub> : 丝杠轴的惯性矩 (Inertia moment of Screw Shaft)	kg·m <sup>2</sup>
I <sub>A</sub> : 丝杠轴侧的齿轮等的惯性矩 (Inertia moment of gears on screw side)	kg·m <sup>2</sup>
I <sub>B</sub> : 电机侧的齿轮等的惯性矩 (Inertia moment of gears on motor side)	kg·m <sup>2</sup>
m <sub>w</sub> : 移动物质量 (Mass of moving object)	kg
m <sub>s</sub> : 丝杠轴质量 (Mass of Screw Shaft)	kg
r : 导程 (Lead)	m
d : 丝杠轴外径 (Screw Shaft diameter)	m
L : 丝杠轴长度 (Ball Screw length)	m
γ : 比重 (Specific gravity)	7,850 kg/m <sup>3</sup>
A : 减速比 (Reduction ratio)	
N : 电机转速 (Motor speed)	min <sup>-1</sup>
t : 加速时间 (Acceleration time)	sec

### ● 负载扭矩 Load Torque T<sub>2</sub>

$$T_2 = \frac{P \cdot r \cdot A}{2\pi\eta} \times 10^{-3} = \frac{(F + \mu W)}{2\pi\eta} \cdot r \cdot A \times 10^{-3} \quad \text{N} \cdot \text{m}$$

$$T_2 = \frac{P \cdot r \cdot A}{2\pi\eta} \times 10^{-1} = \frac{(F + \mu W)}{2\pi\eta} \cdot r \cdot A \times 10^{-1} \quad \text{kgf} \cdot \text{cm}$$

P : 轴向负载 (Axial load)	N {kgf}
F : 负载 (Load)	N {kgf}
W : 移动物重量 (Weight of moving object)	N {kgf}
r : 导程 (Lead)	mm
μ : 滑动面摩擦系数 (Sliding surface friction coefficient)	
η : 效率 (Efficiency) 0.9	
A : 减速比 (Reduction ratio)	

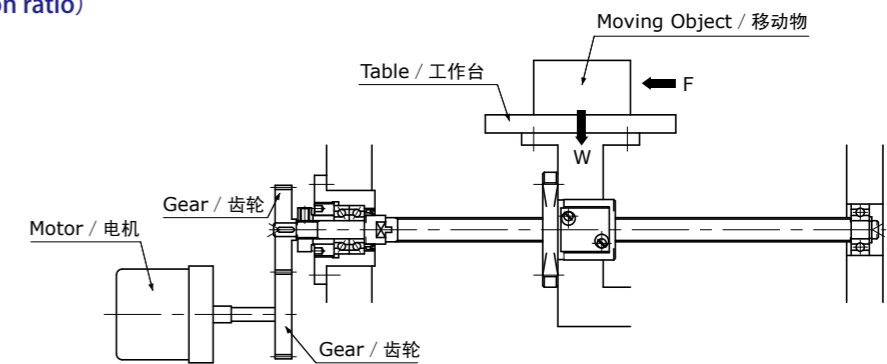

### ● 预压动扭矩 Preload Dynamic Drag Torque T<sub>3</sub>

$$T_3 = 0.05 \times (\tan \beta)^{-0.5} \times \frac{F_a \cdot r}{2\pi} \times 10^{-3} \quad \text{N} \cdot \text{m}$$

$$T_3 = 0.05 \times (\tan \beta)^{-0.5} \times \frac{F_a \cdot r}{2\pi} \times 10^{-1} \quad \text{kgf} \cdot \text{cm}$$

β : 导程角 (Lead angle)	deg
F <sub>a</sub> : 预压负载 (Preload)	N {kgf}
r : 导程 (Lead)	mm

### ● 其他扭矩 Additional Torque T<sub>4</sub>

指上述以外时产生的扭矩。例如支撑轴承的摩擦扭矩及油封滑动阻力产生的扭矩等。

Described as Torque which occurs in addition to those listed above. For example, support Bearing friction Torque, oil seal resistance Torque, etc.

## 防锈与润滑 Rust prevention and Lubrication

### ● 防锈处理

KSS滚珠丝杠以长期存放为前提，涂抹有防锈油。使用前请用清洁的精制煤油将其洗净，并涂抹润滑油或油脂。根据客户的需求，也可在出厂前涂抹油脂，但长期存放时可能会导致丝杠生锈，敬请注意。

注) KSS涂抹的防锈油侧重于防锈性能，并不具备润滑性能。因此，如果在涂有防锈油的状态下直接使用，可能会缩短丝杠寿命、导致扭矩变大、异常发热等问题。

### ● Rust prevention

KSS Ball Screws are applied anti-rust oil when shipping in case of no specific instruction. This oil should be removed before use. Wash Ball Screws with cleaned Kerosine and apply lubricant (Grease or Oil) on Ball Screws. As customer's request, specified Grease or Oil can be applied, but it should be noted that they are not suitable for long term storage purpose and rust might occur.

Note) Anti-rust oil is focused on anti-rust performance and it does not have lubricating function. Therefore, when using Ball Screws with anti-rust oil coating, the problems such as shortened Life, increase of Torque and abnormal heat generation occurs.

### ● 润滑

使用滚珠丝杠时，必须涂抹润滑剂。否则会造成扭矩变大或缩短丝杠使用寿命等问题。涂抹润滑剂可以抑制因摩擦而导致的升温、机械效率下降，以及因磨损而导致的精度下降。滚珠丝杠的润滑方式分为油脂润滑和油润滑。使用油脂润滑时，一般建议使用锂基油脂；使用油润滑时，建议使用ISO VG32~68(透平油)。此外，根据用途选择润滑剂也非常重要。特别是微型滚珠丝杠，油脂的搅拌阻力可能会引起扭矩变大等不良情况。本公司备有可在维持滚珠丝杠动作特性的同时，发挥优异润滑性能的KSS原装油脂。用于注重动作特性的低速定位时，备有MSG No.1(稠度 1号)油脂；用于高速一般用途时，备有MSG No.2(稠度 2号)油脂。详情请参照目录第B101页的“微型滚珠丝杠专用油脂”。

### ● Lubrication

In Ball Screw use, lubricant should be required. If lubricant is not applied with, the problem such as increase of Torque and shortened Life occurs. Applying lubricant can minimize temperature increases, decline of mechanical efficiency due to friction, and deterioration of accuracy caused by wear. Ball Screw lubrication is divided into Greasing and Oiling. A regular lithium-soap-based Grease and ISO VG32-68 Oil (turbine Oil #1 to #3) are recommended. It is highly important to choose lubricant depending on customer's usage. Especially in case of Miniature Ball Screws, malfunction such as increase of Torque are caused by the stir resistance. KSS original Greases which maintains Ball Screw's smooth movement and have high lubricating performance are prepared. MSG No.1 is appropriate for high smooth requirement and high positioning usage (consistency 1). MSG No.2 is suitable for high speed and general usage (consistency 2). Please refer to catalogue page B101 「Original Grease for Miniature Ball Screws」.

一般使用条件下的润滑剂示例

Recommended lubricants for normal operating conditions

Lubricant 润滑剂	Type 种类	Product name 产品名称
Grease 油脂	Lithium-based Grease 锂基油脂	KSS original Grease MSG No.2 KSS原装油脂 MSG No.2
Lubricating Oil 润滑油	Sliding surface Oil or turbine Oil 滑动面油或透平油	Super Multi 68 Super Multi68

### ● 检查和补充

使用油脂润滑时，大致检查时间为每2~3个月，使用油润滑时为每隔1周。检查时，请检查油量及有无脏污，并根据需要加油。

### ● Inspection and replenishment

Grease inspection should be performed once every two to three months, and Oil inspection should be performed approximately weekly. Check the Oil or Grease amount and contamination at each inspection and replenish if needed.

润滑剂的检查和补充时间间隔

Inspection and replenishment Interval of lubricant

Lubrication 润滑方法	Inspection frequency 检查时间间隔	Inspection Items 检点项目	Replenishment and replacement frequency 补充或更换时间间隔
Automatic intermittent lubrication 自动间歇加油	Weekly 每隔1周	Oil level, contamination 油量、脏污等	Replenish at each inspection, depending on tank capacity 根据油箱容量，在每次检查时适量补充。
Grease 油脂	Every 2 to 3 months initially 运行初期2~3个月	Contamination, swarf contamination 脏物、切屑的混入等	Replenish annually or as necessary, depending on Inspection results 通常每1年补充一次，但应根据检查结果适量补充。
Oil bath 油浴	Daily before operation 每天开工前	Oil surface check 油面管理	Set a rule for replenishment as necessary, depending on amount of wear. 根据消耗情况适当规定。

## 防尘 Dust prevention

滚珠丝杠的螺母内如果混入脏物或异物,可能会导致过早磨损、螺纹槽损伤、钢珠破裂和循环部损坏等,从而使滚珠丝杠无法工作。如果可能有上述情形发生,建议采取折皱保护罩和伸缩套管等防尘措施,以避免丝杠部外露。

In Ball Screws, if dust or other contaminations intrude into the Ball Nut, wear is accelerated, the screw groove will be damaged, circulation will be obstructed due to Ball fracture, damage of recirculation parts and so on. Eventually, the Ball Screws will cease to function. Where the possibility of dust or other contaminant exists, the screw thread section cannot be left exposed, and dust prevention measure such as a bellows or Telescopic pipe must be taken.

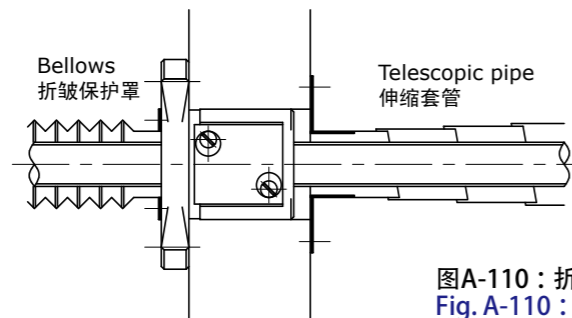

图A-110：折皱保护罩和伸缩套管  
Fig. A-110：Bellows & Telescopic pipe

KSS滚珠丝杠充分发挥微型滚珠丝杠的特点,重视小型化设计。因此,目录中介绍的型号均为不带密封的尺寸。需要密封时,请垂询本公司。螺母尺寸可能会因安装密封而发生变化,敬请注意。此外,某些型号不能安装密封,敬请谅解。

KSS Ball Screws are concentrated on compact design for a feature of Miniature Ball Screw. Therefore, all models in the catalogue are the dimension without seals. Please inquire KSS if seals are required. Please note that Nut dimension may change due to seal installation. Some models cannot install the seals.

## 表面处理 Surface treatment

出于防锈目的,本公司可对滚珠丝杠实施表面处理。本公司的防锈表面处理以黑铬处理为标准。需要其他表面处理时,请垂询本公司。

Surface treatment can be possible for the purpose of rust prevention. Black Chrome treatment (BCr) is KSS standard surface treatment for the purpose of rust prevention. Please inquire KSS if other surface treatments are needed.

### ●KSS黑铬处理滚珠丝杠的特点

- 涂层薄 (2~3μm), 可安装配合零件。
- 在严格的工序管理下,涂膜的厚度均一,不会影响滚珠丝杠的动作特性。
- 覆膜密接性良好,具有优异的防锈能力。
- 是MIL标准 (MIL-DTL-14538D) 公认的表面处理品。
- 需提高滑动特性时,可一并进行氟树脂涂层。

### ●Feature of KSS Ball Screws with Black Chrome (BCr) coating

- Due to thin film thickness (2~3μm), mating part can be applicable with BCr.
- Due to strict production management, film thickness can be treated equally and smoothness is kept.
- High anti-rust ability is possible.
- The surface treatment is officially authorized by MIL standard (MIL-DTL-14538D)
- To improve sliding characteristics, BCr+fluorine resin coating is also available.



照片 A-111：黑铬处理品  
Photo A-111：Black Chrome coating

### ●防锈能力试验数据 Examination data of anti-rust ability

根据盐水喷雾试验,使用标准试样进行的防锈能力评估结果如下所示。

Based on the salt spray corrosion test (JIS Z2371), anti-rust ability has been evaluated, as follows.

- 标准试样 / Standard test piece : 70mm×150mm×1mm (SPCC材/ material=SPCC)
- 数据 / Data : 盐水喷雾试验24小时后的外观和评价数法的评估结果 (数值越小, 腐蚀越严重)

Evaluated by appearance and rating number method after 24 hours of salt spray corrosion test. (The less number, the more corrosion)

	Rating number (Average) 评价数 (平均值)
Sample A (BCr coating) 试样A (BCr处理)	9.3
Sample B (R coating) 试样B (R处理)	9~8
Sample C (M coating) 试样C (M处理)	3~4

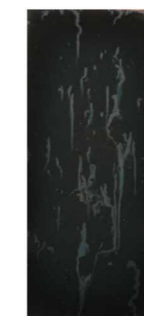

Sample A  
试样A



Sample B  
试样B

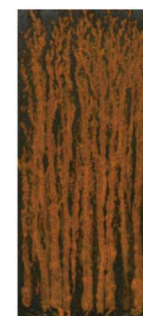

Sample C  
试样C

### ●RoHS指令的符合性 About RoHS compliance

KSS黑铬处理后的滚珠丝杠的Cr<sup>+6</sup>量低于RoHS指令规定的阈值,完全符合RoHS指令。

The Cr<sup>+6</sup> amount of KSS Black Chrome (BCr) coating is less value than the based on RoHS regulation.



# 可追溯性 Traceability

KSS滚珠丝杠的生产采用严格精选的材料,使用先进的生产的设备,在严格的温度管理下进行,从各生产工序到产品检查、出厂,采用一条龙的生产管理体。  
如照片A-112所示,出厂检查合格的滚珠丝杠会发放合格证。如有需要,也可提供检查结果表(照片A-113)。  
本公司生产的滚珠丝杠在螺母上标有生产编号(照片A-114)。与生产编号相应的出厂检查记录及生产记录由本公司保管,通过查询生产编号,可找出所有出厂检查数据。

KSS Ball Screws are manufactured from rigidly selected materials in our temperature controlled factory. They are manufactured using the latest production equipment, with consistent quality control supervision ranging from the production process to inspection and shipping. Certificate of inspection, Photo A-112, will be attached with the Ball Screws which pass shipping inspection. Inspection report can be handed in as customer's request shown in Photo A-113.  
The Ball Screws produced by KSS have a serial number which is marked on the Nut (refer to the Photo A-114). Record of inspection and production trail which is in correspondence to a production number, are stored in KSS and inspection data can be retrieved by inquiry of a serial number.

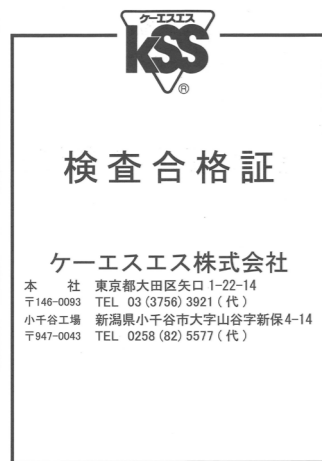

照片 A-112 : 合格证



Photo A-112 : Certificate of Inspection



照片 A-113 : 检查结果表  
Photo A-113 : Inspection report



照片 A-114 : 生产编号  
Photo A-114 : Serial Number

# 滚珠丝杠各种特性的计算示例 Calculation example of characteristic for Ball Screws.

滚珠丝杠各种特性的计算示例如下所示。以下均为模型算式,可能与实际情况有出入,敬请注意。

Calculation example of characteristic for Ball Screws are mentioned as follows. Each calculation example is modeled so that there is a case which is unrealistic.

## 例1: 竖轴规格 Pick&Place Example 1 : Vertical Pick&Place

滚珠丝杠的型号和使用条件  
Ball Screw model and operating condition

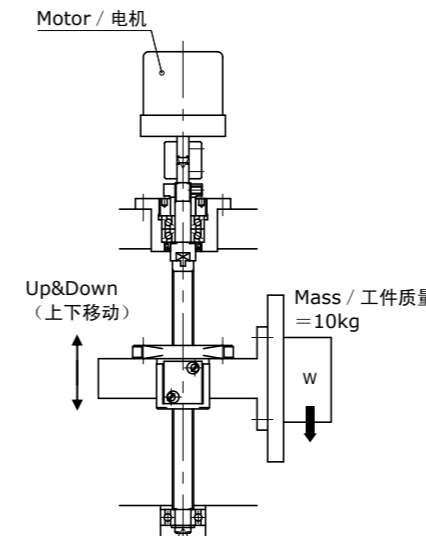

Operating pattern (运行周期线图)

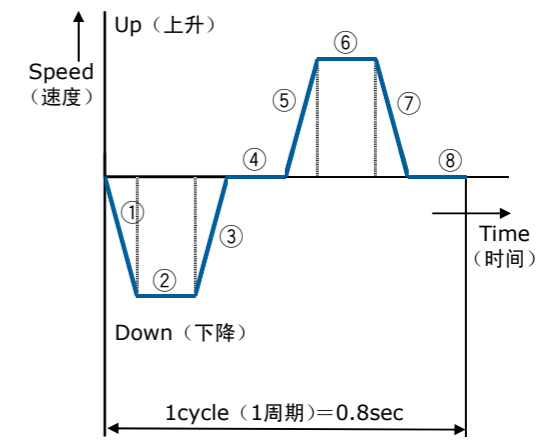

滚珠丝杠的主要技术参数  
轴径=φ10mm  
导程=10mm  
基本额定动负载Ca=3,300N  
滚珠丝杠总长=180mm  
轴向间隙=20μm以下

Ball Screw spec.  
Shaft dia.=φ10mm  
Lead=10mm  
Dynamic Capacity Ca=3,300N  
Total length=180mm  
Axial play=20μm or less

### 运行条件

最高速度=0.4m/sec  
\*\*导程10mm时,2,400 min<sup>-1</sup>  
加减速时间=0.05sec  
\*\*图中1357  
等速时间=0.1sec  
\*\*图中26  
停止时间=0.2sec  
\*\*图中48  
1周期=0.8sec

### Operating Pattern

Max Speed=0.4m/sec  
\*\* 2,400 min<sup>-1</sup> because of Lead 10mm  
Acceleration & Deceleration time=0.05sec  
\*\*1357 in diagram above  
Constant speed time=0.1sec  
\*\*26 in diagram above  
Halt time=0.2sec  
\*\*48 in diagram above  
Cycle time=0.8sec

## 基本额定寿命的计算

## Calculation of Basic Rating Life

基本额定寿命按以下步骤计算得出。

Basic Rating Life is calculated in the following procedure.

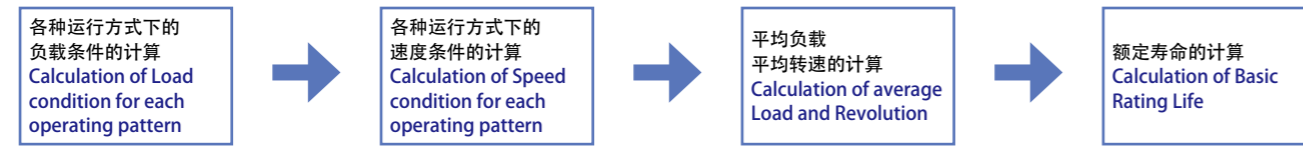

## 1) 负载条件的计算

带编号的各种运行方式的负载条件如下所示。

1下降加速及7上升减速:

$$F_1 = mg - ma$$

2、6等速:

$$F_2 = mg$$

3下降减速及5上升加速:

$$F_3 = mg + ma$$

式中,

m : 移动物质量 = 10kg

g : 重力加速度 = 9.807m/sec<sup>2</sup>

a : 加速度

达到0.4m/sec前的加速度

$$a = 0.4/0.05 = 8\text{m/sec}^2$$

## 1) Calculation of Load condition

Load condition of each operation pattern which is numbered is as follows.

1Down&Acceleration、7Up&Deceleration :

$$F_1 = mg - ma$$

2、6Constant Speed area :

$$F_2 = mg$$

3Down&Deceleration、5Up&Acceleration :

$$F_3 = mg + ma$$

m : Mass = 10kg

g : Gravity Acceleration = 9.807m/sec<sup>2</sup>

a : Acceleration

Acceleration up to 0.4m/sec

$$a = 0.4/0.05 = 8\text{m/sec}^2$$

## 2) 速度条件的计算

带编号的各种运行方式的转速如下所示。

等速时(2、6):

$$0.4 \text{ m/sec} = 0.4 \times 60 \text{ m/min} = 24\text{m/min} \\ = 2,400 \text{ min}^{-1} (\text{导程} 10\text{mm})$$

加减速时(1、3、5、7):

$$\text{上述的平均转速为 } 2,400/2 = 1,200 \text{ min}^{-1}$$

## 2) Calculation of Speed condition

Revolution of each operation pattern which is numbered is as follows.

Constant speed area (2、6) :

$$0.4 \text{ m/sec} = 0.4 \times 60\text{m/min} = 24\text{m/min} \\ = 2,400\text{min}^{-1} (\text{Lead } 10\text{mm})$$

Acceleration and deceleration area (1、3、5、7) :

as above average revolution,  $2,400/2 = 1,200 \text{ min}^{-1}$

## 3) 平均负载、平均转速的计算

总结上述计算结果,算出目录p-A825中所示的平均负载Fam和平均转速N<sub>m</sub>。

## 3) Calculation of average Load, average Revolution

Calculation based on the above, calculate the average Load Fam shown in catalogue p-A825 and the average Revolution N<sub>m</sub>.

$$F_{am} = \left( \frac{F_{a1}^3 \cdot N_1 \cdot t_1 + F_{a2}^3 \cdot N_2 \cdot t_2 + F_{a3}^3 \cdot N_3 \cdot t_3}{N_1 \cdot t_1 + N_2 \cdot t_2 + N_3 \cdot t_3} \right)^{1/3} \text{ N}$$

$$N_m = \frac{N_1 \cdot t_1 + N_2 \cdot t_2 + N_3 \cdot t_3}{t_1 + t_2 + t_3} \text{ min}^{-1}$$

Operating Pattern 条件	Axial load 轴向负载 N	Revolution 转速 min <sup>-1</sup>	time 使用时间 sec
1、7	F <sub>a1</sub> = 18.1	N <sub>1</sub> = 1,200	t <sub>1</sub> = 0.05 × 2 = 0.1
2、6	F <sub>a2</sub> = 98.1	N <sub>2</sub> = 2,400	t <sub>2</sub> = 0.1 × 2 = 0.2
3、5	F <sub>a3</sub> = 178.1	N <sub>3</sub> = 1,200	t <sub>3</sub> = 0.05 × 2 = 0.1
Average 平均	F <sub>am</sub> = 116.3	N <sub>m</sub> = 1,800	Total (合计) 0.4sec 1 cycle (1周期): t = 0.8sec Halt time (停止): 0.4sec (50%)

## 4) 基本额定寿命的计算

使用平均负载、平均转速的值,根据目录第A825页计算基本额定寿命。

## 4) Calculation of Basic Rating Life

Using average Load and average Revolution, Basic Rating Life is calculated according to the catalogue page A825.

$$\text{基本额定寿命 / Basic Rating Life } L_{10h} = \{10^6 / (60 \cdot N_m)\} \times \{C_a / (f \cdot F_{am})\}^3 \quad \text{小时 / hours}$$

$$L_{10h} = 96,280 \quad \text{小时/hours}$$

f : 负载系数 / Load coefficient (假设为1.3/Assumption 1.3)

C<sub>a</sub> : 基本额定动负载 / Basic Dynamic Load Rating (3,300N)

停止时间为50%, 因此运行时间为96,280/0.5 = 192,560小时。

在24小时运行的情况下, 192,560/24 = 8,023天, 因此可确保足够的使用寿命。

Due to halt time is 50%,

96,280/0.5 = 192,560 hours operation.

If 24 hours operation is premised.

192,560/24 = 8,023 days, it shows that enough life is kept.

## 进给丝杠系统的驱动扭矩的计算

根据目录第A827页计算进给丝杠系统的驱动扭矩。这在  
选择电机时非常重要。

上述示例并非预压规格的滚珠丝杠, 所以不产生预压动  
扭矩。因此只计算加速扭矩 $T_1$ 、负载扭矩 $T_2$ 。

$$T = T_1 + T_2 + T_3 + T_4 \quad \text{N}\cdot\text{m}$$

$T_1$ : 加速产生的扭矩 (Acceleration Torque)  $\text{N}\cdot\text{m}$

$T_2$ : 负载扭矩 (Load Torque)  $\text{N}\cdot\text{m}$

$T_3$ : 预压动扭矩 (Preload Dynamic Drag Torque)  $\text{N}\cdot\text{m}$

$T_4$ : 其他扭矩 (Additional Torque)  $\text{N}\cdot\text{m}$

1) 加速扭矩 $T_1$ 的计算 (Calculation of acceleration Torque  $T_1$ )

$$T_1 = \alpha \cdot I = \alpha (I_w + I_s) \text{N}\cdot\text{m}$$

$\alpha$ : 角加速度 (Angular acceleration)  $\text{rad}/\text{sec}^2$

$I$ : 惯性矩 (Inertia moment)  $\text{kg}\cdot\text{m}^2$

$I_w$ : 移动物的电机轴换算的惯性矩  $\text{kg}\cdot\text{m}^2$

(Inertia moment of moving object by motor axial conversion)

$I_s$ : 丝杠轴的惯性矩 (Inertia moment of Screw Shaft)  $\text{kg}\cdot\text{m}^2$

$$I_w = m_w \times (r/2\pi)^2 = 2.53 \times 10^{-5} \text{ kg}\cdot\text{m}^2$$

$m_w$ : 移动物质量 (Mass of moving object) = 10kg

$r$ : 滚珠丝杠导程 (Ball Screw Lead) = 0.01m

$$I_s = m_s \times (d^2/8) = (d/2)^2 \pi \gamma \times L \times (d^2/8) = 0.139 \times 10^{-5} \text{ kg}\cdot\text{m}^2$$

$m_s$ : 丝杠轴质量 (Mass of Screw Shaft) kg

$\gamma$ : 丝杠轴比重 (Specific gravity of Screw Shaft) = 7,850kg/m<sup>3</sup>

$d$ : 丝杠轴外径 (Shaft dia.) = 0.01m

$L$ : 丝杠轴长度 (Shaft length) = 0.18m

$$\alpha = (2\pi N)/60t = 5,026.5 \text{ rad}/\text{sec}^2$$

$N$ : 最高速度 (Max speed) = 2,400min<sup>-1</sup>

$t$ : 加速时间 (Acceleration time) = 0.05sec

$$T_1 = 5,026.5 \times (2.53 + 0.139) \times 10^{-5} = 0.134 \text{ N}\cdot\text{m}$$

2) 负载扭矩 $T_2$ 的计算 (Calculation of Load Torque  $T_2$ )

$$T_2 = mgr / (2\pi\eta) = 0.173 \text{ N}\cdot\text{m}$$

$m$ : 移动物质量 (Mass of moving object) = 10kg

$g$ : 重力加速度 (Gravity Acceleration) = 9.807m/sec<sup>2</sup>

$r$ : 滚珠丝杠导程 (Ball Screw Lead) = 0.01m

$\eta$ : 滚珠丝杠效率 (Ball Screw efficiency) = 0.9

3) 进给丝杠系统的驱动扭矩 $T$ 的计算

根据以上计算, 在不考虑支撑轴承等产生的扭矩时, 滚珠  
丝杠轴系统的驱动扭矩如下所示。

$$T = T_1 + T_2 = 0.134 \text{ N}\cdot\text{m} + 0.173 \text{ N}\cdot\text{m} = 0.307 \text{ N}\cdot\text{m}$$

## Calculation of Driving Torque for feed screw system

Calculate Driving Torque for feed screw system  
according to the catalogue page A827. It is important  
when motor selection. In the above case, due to  
backlash type Ball Screw, Preload Dynamic Drag  
Torque does not occur. Therefore, calculate  
acceleration Torque  $T_1$  and Load Torque  $T_2$ .

## 例2: 横轴规格 小型车床

## Example 2 : Horizontal Small lathe

## 滚珠丝杠的型号和使用条件

## Ball Screw model and operating condition

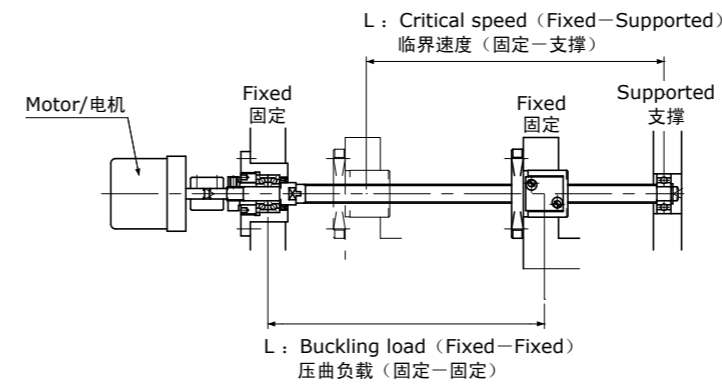

## Operating pattern (运行周期线图)

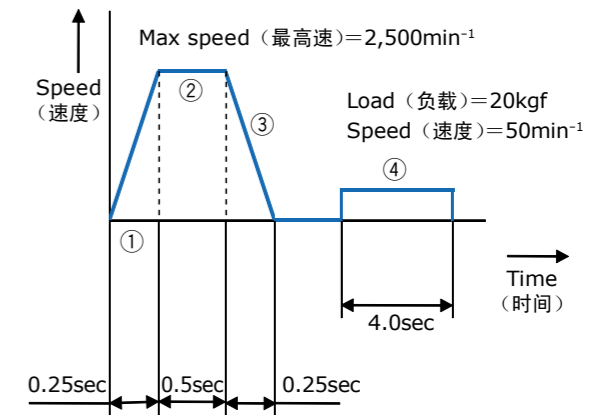

## 滚珠丝杠的主要技术参数

轴径 =  $\phi 12\text{mm}$   
导程 = 2mm  
丝杠轴底径  $d = \phi 10.6\text{mm}$   
基本额定动负载  $C_a = 1,900\text{N}$   
安装间距  $L = 400\text{mm}$   
轴向间隙 = 0 $\mu\text{m}$ 以下  
移动物重量  $W = 500\text{kgf}$   
滑动面摩擦系数  $\mu = 0.01$

## Ball Screw spec.

Shaft dia. =  $\phi 12\text{mm}$   
Lead = 2mm  
Shaft Root dia.  $d = \phi 10.6\text{mm}$   
Dynamic Capacity  $C_a = 1,900\text{N}$   
Mounting span  $L = 400\text{mm}$   
Axial play = 0 $\mu\text{m}$  or less  
Weight of moving object  $W = 500\text{kgf}$   
Sliding surface friction coefficient  $\mu = 0.01$

## 运行条件

最高速度 = 5m/min

\*\*导程2mm时 2,500 min<sup>-1</sup>

周期线图: 参照上图

1加速 = 0.25sec

2等速 = 0.5sec

3减速 = 0.25sec

4负载作用时 = 4.0sec

负载 = 20kgf

切削时进给 = 50min<sup>-1</sup>

## Operating Pattern

Max Speed = 5m/min

\*\* 2,500 min<sup>-1</sup> because of Lead 2mm

Operating pattern: see diagram above

1Acceleration = 0.25sec

2Constant speed = 0.5sec

3Deceleration = 0.25sec

4Working = 4.0sec

Load = 20 kgf

Revolution at turning = 50 min<sup>-1</sup>

## 许用轴向负载的计算

## 1) 弯曲负载的探讨

根据目录第A815页的计算公式来计算压曲负载。

$$P = \alpha \times \frac{n\pi^2 E \cdot I}{L^2} \quad \text{N}$$

将安全系数  $\alpha=0.5$ 、  
杨氏模量  $E=2.08 \times 10^5 \text{N/mm}^2$  (MPa)  
底径  $d=10.6\text{mm}$ 、固定—固定的安装系数  $n=4$ 、  
安装间距  $L=400\text{mm}$  代入上式。

$$P = 15,900\text{N}$$

该值远大于使用负载, 因此没有问题。

## 2) 相对于屈服应力的许用负载的探讨

根据目录第A815页的计算公式计算。

$$P = \sigma \times A \quad \text{N}$$

将许用应力  $\sigma=98\text{N/mm}^2$  (MPa)、  
底径  $d=10.6\text{mm}$  代入上式。

$$P = 8,650 \quad \text{N}$$

该值远大于使用负载, 因此没有问题。

## Calculation of permissible Axial load

## 1) Study of Buckling load

Calculate Buckling load according to the following formula in Catalogue page A815.

$$I = \frac{\pi}{64} d^4 \quad \text{mm}^4$$

Substitute safety factor  $\alpha=0.5$ ,  
Young's modulus  $E=2.08 \times 10^5 \text{N/mm}^2$  (MPa)  
Root diameter  $d=10.6\text{mm}$ ,  
Fixed—Fixed mounting factor  $n=4$ ,  
mounting span distance  $L=400\text{mm}$  in formula above.

$$P = 15,900\text{N}$$

It is more than maximum Load so that there is no problem.

## 2) Study of permissible Load for yield stress

Calculate permissible Load for yield stress based on catalogue page A815.

$$A = \frac{\pi}{4} d^2 \quad \text{mm}^2$$

Substitute permissible stress  $\sigma=98\text{N/mm}^2$  (MPa),  
Root diameter  $d=10.6\text{mm}$  in the formula above.

$$P = 8,650 \quad \text{N}$$

It is more than maximum Load and there is no problem.

## 许用转速的计算

根据目录第A816页的计算公式计算。

$$N = \beta \times \frac{60 \cdot \lambda^2}{2\pi} \times \sqrt{\frac{E \cdot I \cdot g}{\gamma \cdot A \cdot L^4}} \quad \text{min}^{-1} \{\text{rpm}\}$$

$$I = \frac{\pi}{64} d^4 \quad \text{mm}^4$$

$$A = \frac{\pi}{4} d^2 \quad \text{mm}^2$$

将安全系数  $\beta=0.8$ 、  
杨氏模量  $E=2.08 \times 10^5 \text{N/mm}^2$  (MPa)、  
重力加速度  $g=9.8 \times 10^3 \text{mm/sec}^2$   
比重  $\gamma=7.7 \times 10^{-5} \text{N/mm}^3$ 、  
底径  $d=10.6\text{mm}$ 、  
固定—支撑的安装系数  $\lambda=3.927$ 、  
安装间距  $L=400\text{mm}$  代入上式。

$$N = 10,000 \text{min}^{-1}$$

该值远大于最高转速, 因此没有问题。

## Calculation of permissible Revolution

Calculate permissible Revolution based on the catalogue page A816

Substitute safety factor  $\beta=0.8$ ,  
Young's modulus  $E=2.08 \times 10^5 \text{N/mm}^2$  (MPa),  
gravity acceleration  $g=9.8 \times 10^3 \text{mm/sec}^2$ ,  
material specific gravity  $\gamma=7.7 \times 10^{-5} \text{N/mm}^3$ ,  
Root diameter  $d=10.6\text{mm}$ ,  
Fixed—Support mounting factor  $\lambda=3.927$ ,  
mounting span distance  $L=400\text{mm}$  in formula above.

$$N = 10,000 \text{min}^{-1}$$

Therefore, it is more than maximum Revolution and there is no problem.

## 基本额定寿命的计算 Calculation of Basic Rating Life

## 1) 根据周期线图计算负载条件

Calculation of Load condition according to the operating pattern diagram

速度 (Speed)  $V=5\text{m/min} = 83.3\text{mm/sec}$   
 加速度 (Acceleration)  $a = 83.3/0.25 = 333 \text{ mm/sec}^2 = 0.333 \text{ m/sec}^2$   
 加速产生的负载 (Load due to Acceleration)  $F = ma = 500 \times 0.333 = 167 \text{ N}$   
 移动时的负载 (Load of moving object) = 等速时的负载 (Load during constant speed)  $F_1 = \mu mg = 49\text{N}$   
 恒速时的转速 (Revolution at constant speed)  $N_1 = 2,500 \text{ min}^{-1}$   
 加速时的负载 (Load during acceleration)  $F_2 = F + F_1 = 216\text{N}$   
 加速时的转速 (Revolution at acceleration)  $N_2 = 2,500 / 2 = 1,250 \text{ min}^{-1}$   
 切削时的负载 (Load during turning)  $F_4 = 200\text{N} + F_1 = 249\text{N}$   
 切削时的转速 (Revolution at turning)  $N_4 = 50 \text{ min}^{-1}$

总结上述结果, 如下表所示。

Sum up calculation results above, results are as follows.

Operating Pattern 条件	Axial load (F) 负载 (F) N	Revolution 转速 $\text{min}^{-1}$	time (t) 使用时间 (t) sec	Percentage 使用频率 %
1 Acceleration (加速)	216	1,250	0.25	5
2 Constant Speed (等速)	49	2,500	0.5	10
3 Deceleration (减速)	216	1,250	0.25	5
4 Turning (切削)	249	50	4.0	80

## 2) 平均负载、平均转速的计算

根据目录第A825页计算平均负载。

## 2) Calculation of average Load, average Revolution

According to catalogue page A825, average Load  $F_{am}$  is as follows.

$$F_{am} = \left( \frac{F_1^3 N_1 t_1 + F_2^3 N_2 t_2 + F_3^3 N_3 t_3 + F_4^3 N_4 t_4}{N_1 t_1 + N_2 t_2 + N_3 t_3 + N_4 t_4} \right)^{1/3} \text{ N}$$

将上表中的数值代入后得出,  $F_{am} = 166\text{N}$ Substitute each number in table in the formula above,  $F_{am} = 166\text{N}$ 此外, 将上表的数值代入目录第A825页的公式, 得出平均转速  $N_m = 415 \text{ min}^{-1}$ 。In case of the average Revolution, substitute each number in table in the following formula,  $N_m = 415 \text{ min}^{-1}$ 

$$N_m = \left( \frac{N_1 t_1 + N_2 t_2 + N_3 t_3 + N_4 t_4}{t_1 + t_2 + t_3 + t_4} \right) = 415 \text{ min}^{-1}$$

## 3) 基本额定寿命的计算

将平均负载  $F_{am}$  和平均转速  $N_m$  代入目录第A825页的寿命计算公式中, 可得出以下结果。

## 3) Calculation of Basic Rating Life

Substitute the average Load  $F_{am}$  and Revolution  $N_m$  in the following formula, page A825 in catalogue.

$$L_{10h} = \left( \frac{10^6}{60 \cdot N_m} \right) \times \left( \frac{C_a}{f \cdot F_{am}} \right)^3 = 3.48 \times 10^4 \text{ 小时 (hours)}$$

其中, 假设基本额定动负载  $C_a = 1900\text{N}$ 、负载系数  $f = 1.2$ 。Here, Basic Dynamic Load Rating  $C_a = 1900\text{N}$ , Load factor  $f = 1.2$ .

## 存放、操作及使用注意事项

### ● 滚珠丝杠操作注意事项

滚珠丝杠属于精密零件,请遵照下述事项谨慎操作。

#### 存放

存放时,请保持本公司原装包装状态。请勿随意开包或弄破内部包装。否则会有异物进入或生锈,从而导致产品性能下降。

#### 操作

1. 严禁拆分产品。否则会导致异物进入、精度下降或引发事故。
2. 重新组装时,如果组装错误,可能会导致滚珠丝杠的功能丧失。因此,客户请勿自行重新组装。请将产品送回本公司,我们将有偿为您维修并重新组装。
3. 滚珠丝杠的轴和螺母可能会因自重而掉落,请注意避免受伤。如果掉落,可能会因循环部件受损而导致性能下降,因此请务必委托本公司进行检查。请务必将产品送回本公司。我们将有偿为您检查。
4. 如果滚珠丝杠掉落,循环部件、轴的外径以及钢珠等可能会划伤、损坏。这可能会导致产品功能丧失,如回转不良等。

### ● 滚珠丝杠使用注意事项

#### 防尘

请在清洁环境下使用滚珠丝杠。请同时使用防尘罩等防止异物、切屑等进入滚珠丝杠中。如果因防尘不当而导致异物、切屑等进入滚珠丝杠,可能会降低滚珠丝杠的性能或损坏循环部件,从而导致产品锁死。

#### 润滑

请在使用前确认润滑状况。如果润滑不良,可能会导致滚珠丝杠在短期内丧失功能。此外,防锈油并非润滑剂,使用前请用精制煤油等清洗滚珠丝杠,去除防锈油后涂上润滑剂(油脂或润滑油)。在常规用途下使用时,请每2~3个月检查一次油脂。使用过程中油脂变脏时,请擦去旧的油脂后涂抹新油脂。

#### 许用转速和许用轴向负载

根据尺寸、材质及安装方式等不同,滚珠丝杠会受到轴向负载和转速的限制。建议在产品的设计阶段就使用条件与本公司充分协商。关于使用条件,请充分利用卷末的技术数据表。

#### 超程

滚珠丝杠螺母发生超程时,可能导致钢珠脱落、循环部件受损或钢珠槽产生压痕等,从而引起动作不良。如果在该状态下继续使用,还可能导致早期磨损或循环部件损坏。因此请务必避免超程。发生超程时,请与本公司联系检查事宜。我们将有偿为您检查。

#### 使用温度

使用温度的极限通常设计在80°C以下。超过该温度使用时,可能会产生如下现象:

- 钢珠循环性能下降;
- 循环部件损伤或损坏;
- 相对于热处理部位的硬度降低。

如需在超过80°C的条件下使用,请垂询本公司。

#### 偏负载

滚珠丝杠是一种产生轴向推力的机械元件,其结构不能承受径向负载和力矩负载。请注意避免对螺母部施加径向负载和力矩负载。如果滚珠丝杠承受径向负载或力矩负载,将会导致滚珠负载不均,从而显著缩短产品的使用寿命。另外,安装滚珠丝杠时,轴承部与螺母托架之间的偏心也会导致偏负载,敬请注意。

#### 摇摆运动

让滚珠丝杠做摇摆运动(重复进行短行程+正反转)时,由于滚珠的相互挤压,动扭矩有逐渐增大的倾向。这个问题可通过定期使用假行程(全行程)来解决。

## Precaution of storage, handling and operating

### ● Handling precaution for Ball Screws

Ball screws are precision components, and must be handled carefully in accordance with the instruction below.

#### Storage

Ball Screws should be stored unopened in their original KSS packaging. Avoid opening the package or breaking the inner package unnecessarily. This may result in contamination or rusting, and may degrade operating performance.

#### Handling

1. Never disassemble Ball Screws. This will cause contamination, reduce accuracy, and lead to accidents.
2. Customers should not attempt to reassemble Ball Screws themselves. Incorrect reassembly can easily result in malfunction. Ball Screws should be returned to KSS, where they will be repaired and reassembled for a fee.
3. Take care to avoid injuries due to falling Ball Screw Shafts or Nuts. If dropped, performance may be adversely affected by damage to the recirculating component. Ball Screws must therefore be inspected by KSS for a fee. Please make sure you return dropped Shafts or Nuts.
4. Dropping Ball Screws may cause scratching or impact damage to recirculating components, Shaft outside diameters, Balls, or screw grooves, which may cause malfunction, such as incorrect rotation.

### ● Precaution of Ball Screw for operating

#### Dust proof

Ball Screws must be used in a clean environment. They should be used with a dustproof cover to prevent contamination from dust or swarf. Dust or swarf contamination due to insufficient dust protection may reduce the Ball Screw performance, cause damage to recirculating components, which lead to locking.

#### Lubrication

Check lubrication before use. Insufficient lubrication will rapidly deteriorate the operating performance of the Ball Screw. Since anti-rust oil is not lubricant (Grease/ Oil), Ball Screws should be washed off anti-rust oil with clean Kerosene and apply lubricant before using Ball Screws. Please check the lubricant condition every 2 to 3 months. If Grease is contaminated, remove old Grease, and replace with new Grease.

#### Critical speed and Axial load

Ball Screws have the maximum limit of speed and Axial load depending on its size, material, mounting method etc. when design Ball Screws, KSS would recommend that you consult with KSS engineering about the operating condition and model selection. To release your operating condition, please use Technical Data Sheet at the end of this catalogue.

#### Over-run

Allowing Ball Screw Nuts to overrun may result in malfunctioning due to Balls escaping, damage to recirculation components, and indentation of the Ball grooves. Continued use in this state will lead to rapid wear and damage to recirculation components. Ball Screw Nuts must therefore never be allowed to overrun. If overrunning occurs, contact KSS for an inspection for a fee.

#### Temperature

Ball Screws are designed to be used at operating temperatures up to 80°C. Avoid use at higher temperatures. This may result in the following problems .

- Reduced performance of Ball recirculation, and smooth movement.
- Damage to recirculation components.
- Reduced hardness of heat treated components.

If it is necessary to work beyond the recommended temperatures, please consult with KSS first as we may be able to provide a solution.

#### Moment load or Radial load

Ball Screws primarily generate thrusts in the axial direction, and are not designed to withstand Radial loads and Moment loads. Care must be taken not to apply Radial loads and Moment loads to the Nut. If there loads act on the Ball Screws, Ball load uniformity is lost, and the life of Ball Screws is drastically reduced. When installing Ball Screws, misalignment between Ball Screw and Support Bearings or Nut Bracket causes the unbalanced load on Ball Screw, care must be taken.

#### Oscillation

Under the oscillation (short stroke + back & forth operation) of Ball Screws, Drag Torque tends to increase gradually due to the stuck of Balls inside Ball Nut. Dummy stroke (preferably full length stroke) would be effective to release this phenomenon.